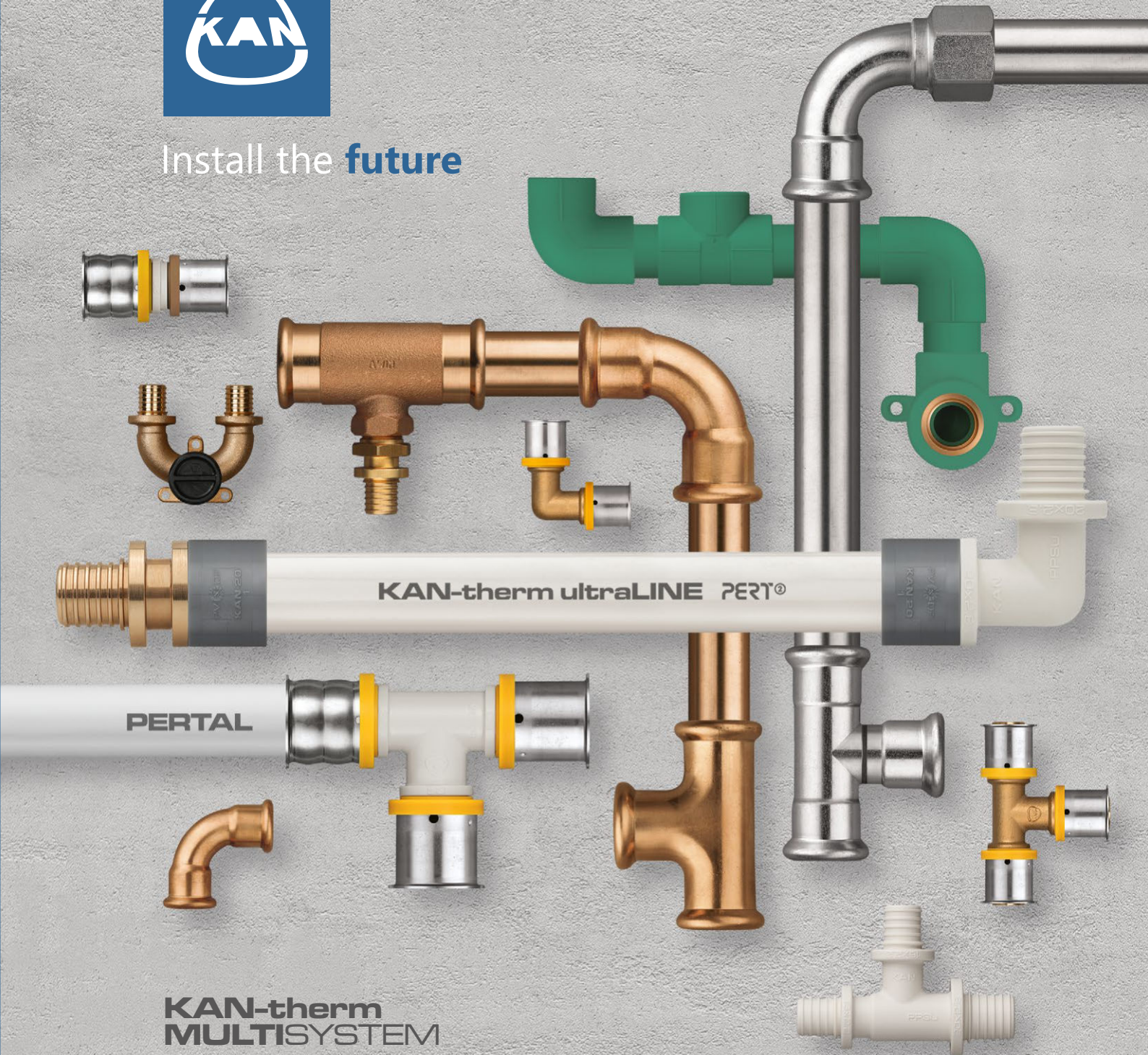




Install the **future**



**KAN-therm**  
**MULTISYSTEM**

# Catalogue

WATER INSTALLATION  
HEATING AND COOLING



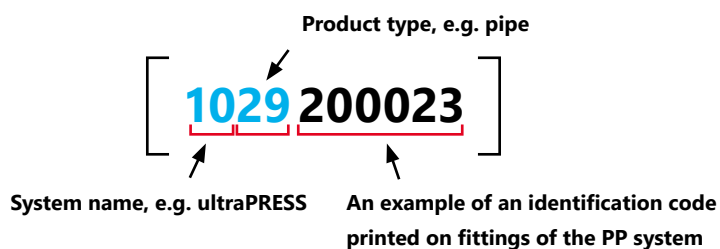


## Contents

<b>SYSTEM KAN-therm ultraPRESS</b> .....	<b>5</b>
pipes and fittings with crimping sleeve for heating and potable water systems	
<b>SYSTEM KAN-therm PP Green</b> .....	<b>59</b>
welded pipes and fittings for heating and potable water systems	
<b>SYSTEM KAN-therm Inox</b> .....	<b>99</b>
stainless steel pipes and fittings for heating and potable water systems	
<b>The surface heating and cooling of the SYSTEM KAN-therm</b> .....	<b>151</b>
solutions for low-temperature surface heating and cooling systems	

## EXPLANATION OF CODE SYSTEM

Pipes	29	Fittings	09
-------	----	----------	----



ultraPRESS	10	Manifolds	13
PP Green	20	Screw fittings and supp. elements	17
Inox	16	Tools	19
Surface heating and cooling	18	Others	21
Cabinets	14		



Install your **future**



SYSTEM **KAN-therm**

# ultra**PRESS**

Innovativeness and uniqueness  
- One system, six functions

# 1 SYSTEM **KAN-therm** ultraPRESS

<b>1.1</b>	<b>General information</b>	<b>7</b>
<b>1.2</b>	<b>Pipes in the KAN-therm ultraPRESS</b>	<b>8</b>
	PERTAL pipes with aluminum layer	8
	PEXC, PERT and bluePERT pipes with EVOH layer and bluePERTAL with aluminium layer	10
	Scope of use	11
<b>1.3</b>	<b>Joints in multilayer installations with KAN-therm pipe with aluminium layer</b>	<b>12</b>
	„Press“ joints	12
	Design and features of KAN-therm 16-40 mm ultraPRESS fittings	13
	Identification of KAN-therm ultraPRESS fittings	14
	KAN-therm ultraPRESS fittings with diameters 50 and 63 mm	14
	KAN-therm pressed fittings – assortment	15
	Contact with chemicals, adhesives and sealants	17
	Performing “press” type connections for KAN-therm ultraPRESS fittings	18
	Assembly of KAN-therm ultraPRESS fittings with diameters: 16, 20, 25, 26, 32 and 40 mm	23
	Assembly of KAN-therm ultraPRESS fittings with diameters 50 and 63 mm	25
	Minimum assembly distances	26
	Threaded joints for PERTAL pipes with aluminum layer	26
<b>1.4</b>	<b>Transport and storage</b>	<b>29</b>

## System **KAN-therm** ultraPRESS - assortment

Pipes	31
Connectors	32
Accessories	47
Tools	49

# 1 SYSTEM KAN-therm ultraPRESS

## 1.1 General information

KAN-therm ultraPRESS is a state-of-the-art, complete installation system consisting of PERTAL polyethylene pipes with aluminum layer, as well as PPSU or brass fittings of Ø16–63 mm.

Connection of the system ultraPRESS elements is based on pressing a stainless steel sleeve on a pipe mounted on a stub of a fitting or coupling ("press" technique). The stub is equipped with O-Rings ensuring complete tightness of the joint and reliable operation of the installation.

The system is designed for indoor water supply installations (cold and hot potable water), central heating installations, cooling installations, technological heating installations and industrial installations (compressed air).

The ultraPRESS system offers the additional possibility of connecting PERT, PEXC and bluePERT pipes with an EVOH layer and bluePERTAL pipes with aluminium layer by using ultraPRESS fittings in brass and PPSU. In this case, the operating conditions for such a connection, described later in this guide, should be checked.

KAN-therm ultraPRESS is characterized by:

- high operating parameters (max. working temperature of 90 °C, permissible malfunction temperature – 100 °C),
- very low thermal elongation of PERTAL pipes with aluminum layer,
- complete lack of oxygen diffusion to installation water,
- guaranteed durability for over 50 years,
- universal pipe applications (one pipe for combined water supply and heating installations),
- resistance to hydraulic impact,
- high smoothness of internal surfaces,
- resistance to scaling,
- physiological and microbiological neutrality in potable water installations,
- environmentally friendly materials,
- easy and quick installation,
- easy and quick assembly (no chamfering or calibration of pipes with diameters of 16-32 mm required),
- low installation weight,
- possibility of executing joints in structural partitions,
- LBP function, i.e. indication of unpressed connections,
- Universality - PERT, PEXC and bluePERT pipes with EVOH layer and bluePERTAL pipes with aluminium layer can be connected.

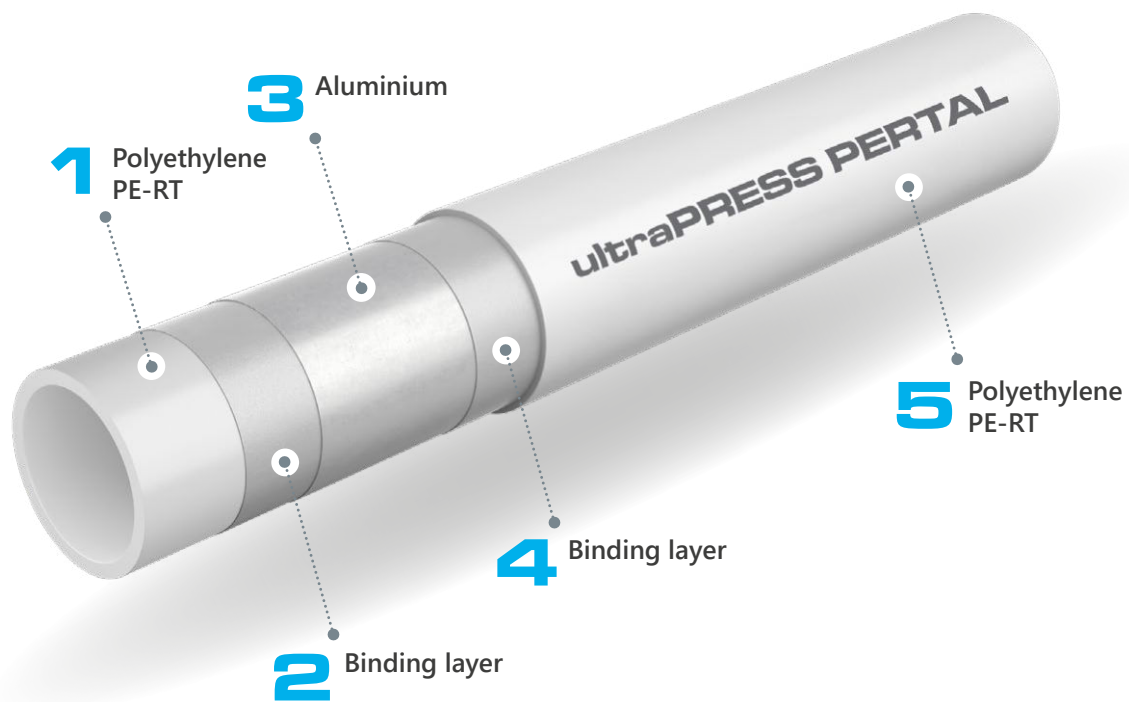
## 1.2 Pipes in the KAN-therm ultraPRESS

### PERTAL pipes with aluminum layer

Multilayer PERTAL pipes with aluminum layer in KAN-therm ultraPRESS system are offered in PE-RT/Al/PE-RT construction (diameter range of Ø16–63 mm).

They are made of the following layers: internal layer (base pipe) made of PE-RT polyethylene with increased thermal resistance, middle layer as laser butt-welded aluminium and external layer (coating) made of PE-RT polyethylene as well. An adhesive binding layer is applied between the aluminum and plastic layers.

The aluminum layer serves as a anti-diffusion barrier and lowers the thermal pipe elongation 8 times, as compared to uniform polyethylene pipes. Thanks to the butt welding of aluminium, all the pipe layers have constant, specified thickness and perfectly round cross-section.



Cross-section of a PERTAL pipes with aluminium layer

#### Physical properties of PERTAL pipes with aluminum layer

Property	Symbol	Unit	Value
Linear elongation coefficient	$\alpha$	mm/m × K	0,023 – 0,025
Thermal conductivity	$\lambda$	W/m × K	0,43
Minimal bending radius	$R_{min}$		5 × De - without tools 3,5 × De - while utilizing bending tools
Internal wall roughness	k	mm	0,007





KAN-therm ultraPRESS PERTAL pipes with aluminum layer

## Marking, color of pipes

All pipes are marked with permanent descriptions with a 1-m span, containing i. a. the following indications:

Marking description	Example of marking
Name of manufacturer and/or trademark:	KAN-therm ultraPRESS PERTAL
Nominal external diameter x wall thickness	16 x 2
Pipe structure (material)	PE-RT/Al/PE-RT
Pipe code	1029196031
Number of standard or Technical Certificate	KIWA KOMO, DVGW
Application class/es with design pressure	Class 2/10 bar, Class 5/10 bar
Date of production	18.08.09
Other manufacturer markings, e.g. running meter, batch number	045 m



**Notice – other, additional markings, e.g. numbers of certificates may also be inscribed on the pipe.**

**Pipe color:** white.

Pipes are supplied in coils in lengths depending on the diameter of the pipe and its version, i.e. with or without thermal insulation.

Pipes without thermal insulation are also available in 5 m bars.

## Dimension parameters of KAN-therm PERTAL pipes with aluminum layer

DN	External diameter x wall thickness	Wall thickness	Internal diameter	Weight by unit	Number in roll/bar	Water capacity
	mm x mm	mm	mm	kg/m	m	l/m
PERTAL						
16	16 x 2,0	2,0	12	0,129	200- 600 / -	0,113
20	20 x 2,0	2,0	16	0,152	100 / 5	0,201
25	25 x 2,5	2,5	20	0,239	50 / 5	0,314
26	26 x 3,0	3,0	20	0,296	50 / -	0,314
32	32 x 3,0	3,0	26	0,365	50 / 5	0,531
40	40 x 3,5	3,5	33	0,510	25 / 5	0,855
50	50 x 4,0	4,0	42	0,885	- / 5	1,385
63	63 x 4,5	4,5	54	1,265	- / 5	2,290

## PEXC, PERT and bluePERT pipes with EVOH layer and bluePERTAL with aluminium layer

The basic configuration of the ultraPRESS system is to combine ultraPRESS fittings with PERTAL pipe with aluminium layer, in the entire diameter range 16-63 mm. The special design of ultraPRESS fittings gives the additional option of connecting PERT, PEXC, bluePERT and bluePERTAL pipes in the 16-25 mm diameter range.

The operating conditions for pipes, depending on the application class, type of pipe and its diameter, are presented in the table further on in this guidebook.



KAN-therm ultraPRESS tee in combination with bluePERT, PEXC and PERT pipe.

## Scope of use

KAN-therm ultraPRESS pipes and fittings are in full compliance with all applicable standards, which guarantees their long-term and reliable operation as well as full security of assembly and use of the installation.

- PPSU and brass ultraPRESS joints utilizing pressed rings and threaded brass fittings: compliance with approved for use by the National Institute of Hygiene,
- PERTAL pipes: compliance with EN ISO 21003–2:2009, approved for use by the National Institute of Hygiene,

The working parameters and scopes of use of KAN-therm PERTAL pipe installations are presented in the table.

Application (acc. to ISO 10508)	$T_{op}/T_{max}$ [°C]	Dimensions [mm]	Operating pressure $P_{op}$ [bar]		Connection type	
			PERTAL	PERTAL	"press"	screw
					PERTAL	PERTAL
Cold tap water Hot tap water <b>[Application class 1(2)]</b>	60(70)/80	16 × 2,0	10	PERTAL	+	+
		20 × 2,0			+	+
		25 × 2,5			+	+
		26 × 3,0			+	+
		32 × 3,0			+	-
		40 × 3,5			+	-
		50 × 4,0			+	-
		63 × 4,5			+	-
Radiant heating, low-temperature radiator heating <b>[Application class 4]</b>	60/70	16 × 2,0	10	PERTAL	+	+
		20 × 2,0			+	+
		25 × 2,5			+	+
		26 × 3,0			+	+
		32 × 3,0			+	-
		40 × 3,5			+	-
		50 × 4,0			+	-
		63 × 4,5			+	-
Radiator heating <b>[Application class 5]</b>	80/90	16 × 2,0	10	PERTAL	+	+
		20 × 2,0			+	+
		25 × 2,5			+	+
		26 × 3,0			+	+
		32 × 3,0			+	-
		40 × 3,5			+	-
		50 × 4,0			+	-
		63 × 4,5			+	-

For all classes and diameters, failure temperature  $T_{mal} = 100$  °C

The operating parameters and applications scope of the KAN-therm ultraPRESS system with the use of PEXC, PERT, bluePERT and bluePERTAL pipes are presented in the table:

Application class	Operating pressure $P_{op}$ [bar]					Connection type	
	$T_{op}/T_{max}$	Dimensions	PEXC	PERT	bluePERT, bluePERTAL*	„press“	screw
	[°C]	[mm]				PEXC, PERT, bluePERT, bluePERTAL*	PEXC, PERT, bluePERT, bluePERTAL*
Cold tap water	20	16 × 2,0	10	10	-	+	+
		20 × 2,0	10	10	-	+	+
Hot tap water [Application class 1]	60/80	16 × 2,0	10	10	-	+	+
		20 × 2,0	8	8	-	+	+
Hot tap water [Application class 2]	70/80	16 × 2,0	10	10	-	+	+
		20 × 2,0	6	8	-	+	+
Underfloor heating, Low temperature heating, radiant heating [Application class 4]	60/70	16 × 2,0*	10	10	8	+	+
		20 × 2,0	8	8	6	+	+
		25 × 2,5	-	-	6	+	-
Radiator heating [Application class 5]	80/90	16 × 2,0	8	8	-	+	+
		20 × 2,0	6	6	-	+	+

Operating pressure calculated according to the standards: PN-EN ISO 15875-2:2004 for PEXC pipes and PN-EN ISO 21003-2:2009 for PERT, bluePERT and bluePERTAL pipes.

### 1.3 Joints in multilayer installations with KAN-therm pipe with aluminium layer

The basic method of connecting pipes in the KAN-therm ultraPRESS is using the “press” technique utilizing a radially pressed stainless steel sleeve. Threaded joints may also be used to connect pipes to devices and appliances.

#### „Press“ joints

The execution of „press“ type joints is based on radially pressing stainless steel sleeve located on the stub of a fitting. The stub is equipped with O-Ring sealing made of synthetic EPDM rubber, resistant to high temperatures and pressure. The sleeve is pressed with a manual or electric press tool equipped, depending on the diameter of the pipe, with “U”, “C”, or “TH” profile jaws (standard pressing). Such a connection allows conducting the installation in structural partitions (in flooring finishing coats and under layers of plaster).

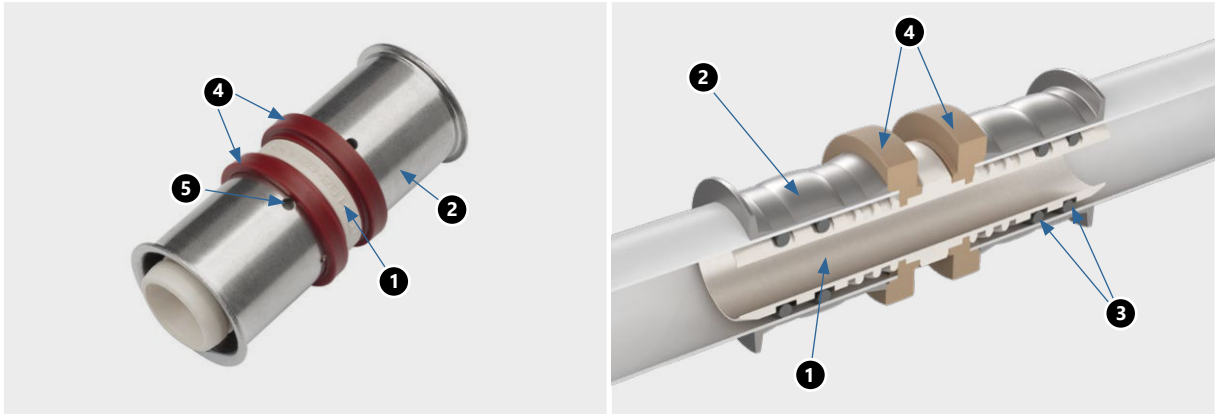
Press KAN-therm fittings, depending on the diameter, are available in three construction types. They differ in terms of outer appearance, methods of assembly and some functions:

- KAN-therm ultraPRESS fittings (with colored rings) – diameters 16, 20, 25, 26, 32 and 40 mm,
- KAN-therm ultraPRESS fittings (with transparent rings) – diameters 50 and 63 mm,
- KAN-therm ultraPRESS fittings (without base rings - old design) - diameters 50 and 63 mm.

## Design and features of KAN-therm 16-40 mm ultraPRESS fittings

Thanks to their special design this type of KAN-therm ultraPRESS fittings is characterized by:

- a function of signaling not-pressed LBP joint (does not refer to the fittings with 40 mm diameter),
- possibility of using U, C or TH profile jaws interchangeably (depending on the diameter and jaw manufacturer),
- elimination of need to chamfer the edge of the pipe,
- precise jaws positioning on the ring,
- colored, plastic specifying the fitting diameter rings.



View and cross-section of a KAN-therm ultraPRESS with a colored ring fitting

1. Coupling body
2. Pressed stainless steel sleeve with inspection holes
3. EPDM O-Rings
4. Color plastic base ring
5. Inspection holes in the stainless steel sleeve

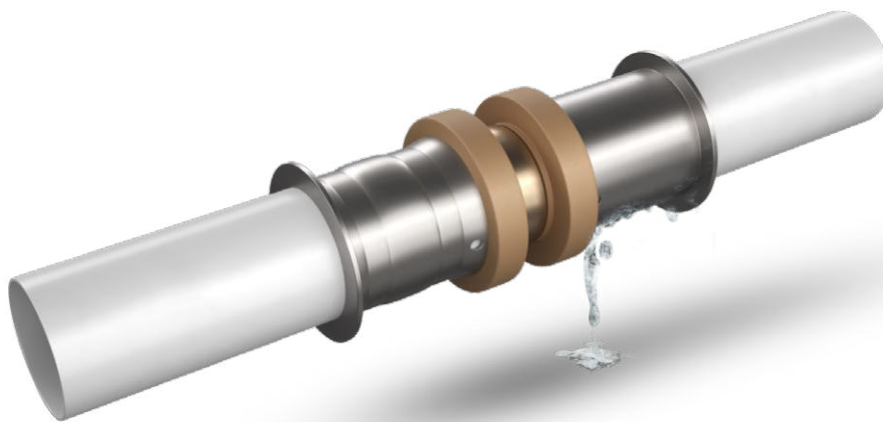
**LBP – „Leak Before Press“** – an mistakenly not-pressed joints are signaled by a water leak at the stage of preliminary non-pressurized installation filling, before the pressure test. This function complies with DVGW guidelines (“controlled leak”).



### Notice:

According to DVGW guidelines, the LBP function can be seen as controlled leakage at a pressure of:

- in compressed air installations from 1,0 to 3,0 bar,
- in installations filled with water from 1,0 to 6,5 bar.



LBP function in action – leak before press

## Identification of KAN-therm ultraPRESS fittings

KAN-therm ultraPRESS fittings with diameters of 16 mm up to 40 mm are equipped with special plastic base ring, the color of which depends on the diameter of the pipe being connected. This solution facilitates the identification of the fitting and, in consequence, installation works at the construction site and in the warehouse. Irrespective of the color identification, each stub has a marking stating the diameters of pipes to be connected.

The dimensions of pipes (external diameter × wall thickness) are also inscribed on the stainless steel sleeve.

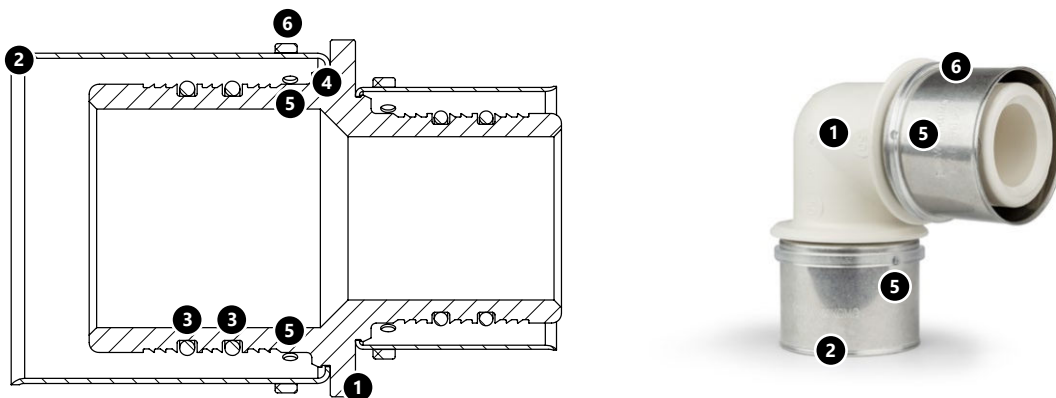


\* 40 mm fittings do not possess LBP function itself

## KAN-therm ultraPRESS fittings with diameters 50 and 63 mm

All fittings of diameter – 50 and 63 mm (including 50 and 63 mm stubs of reduction joints) differ in design from their substitutes with smaller diameters. They are distinguished by plastic transparent base ring embedded on a fittings body, the lack of LBP function and a slightly different method of assembly in terms of pipe ending treatment.

**i** **Note! Old designs of 50 and 63 mm diameter fittings may be available on the market, characterized by the absence of the LBP function, the lack of a base ring and a different way of positioning the jaws. Detailed installation guidelines are described later in this guide.**



View and cross-section of KAN-therm ultraPRESS fitting without a colored ring.

1. Fitting body
2. Pressed stainless steel sleeve
3. EPDM O-Rings
4. Rings positioning the stainless steel sleeve on the body
5. Inspection holes in the sleeve
6. Plastic transparent base ring

## KAN-therm pressed fittings – assortment

The KAN-therm ultraPRESS system offers a wide selection of radially pressed fittings:

- elbows and tees, couplings,
- elbows, tees and other fittings with 15 mm nickel-plated pipes for connecting to radiators and appliances,
- fittings with male and female threads, and eurocone adapters,
- tap connections,
- transition couplings.

KAN-therm ultraPRESS fittings are offered in two structural variations:

### KAN-therm ultraPRESS fittings with colored ring (diameters 16–40 mm)



KAN-therm ultraPRESS radially pressed fittings



KAN-therm ultraPRESS pressed fittings with 15 mm pipes for connecting to radiators\*



KAN-therm ultraPRESS pressed fittings with threads and eurocone adapters\*



KAN-therm ultraPRESS pressed fittings – tap connections\*

- i** \*The application of KAN-therm ultraPRESS system fittings for connecting radiators and water supply taps is described in the chapter titled "Connections of water supply and heating installation devices in the KAN-therm system".



KAN-therm ultraPRESS pressed couplings – transition fittings



## KAN-therm ultraPRESS fittings with transparent ring (diameters 50–63 mm)



KAN-therm ultraPRESS fittings



Threaded KAN-therm ultraPRESS fittings

**i** The application of KAN-therm ultraPRESS system fittings for connecting radiators and water supply taps is described in the chapter titled “Connections of water supply and heating installation devices in the KAN-therm system”.



All KAN-therm ultraPRESS fittings with the diameter range 16-63 mm are made of a reliable structural material polyphenylsulfone (PPSU) or high quality CW617N brass. PPSU is used to manufacture elbows, tees and tap connections. The properties and advantages of PPSU are discussed in the chapter KAN-therm Push system: PPSU – perfect installation material.

### Contact with chemicals, adhesives and sealants

- Secure the plastic (PPSU) elements of KAN-therm system against contact with paints, primers, solvents or materials containing solvents, e.g. varnish, aerosols, expanding foams, adhesives, etc. In unfavorable circumstances, these substances could potentially damage the plastic elements of the system.
- Make sure that substances sealing the joints, cleaning solutions or solutions used to insulate KAN-therm system components do not contain any compounds which could cause stress cracks. These include ammonia, solutions containing ammonia, aromatic solvents and compounds retaining oxygen (e.g. ketone or ether) or chlorinated hydrocarbons.
- Do not use expanding foams based on methacrylate, isocyanate and acrylate when in contact with plastic (PPSU) elements of KAN-therm system. Avoid direct contact of plastic (PPSU) fittings and pipes with adhesive tapes and adhesives for insulation.
- In threaded fittings, use a proper amount of tow as to leave the ending of the thread bare and visible. Too much tow may disrupt the thread. Winding tow just above the first coil of the thread will prevent the tow from tangling up and the thread from being damaged.
- When making screw (threaded) connections, precautions must be taken in the form of: the use of an appropriate amount of sealing material (tow), the correct degree of screwing in of the connection. In unfavorable situations, a threaded connection made with too much sealant and/or screwed in with excessive force can lead to critical mechanical stresses in the connector material and damage to the product.
- Pay attention to connecting different types of threads. In unfavorable cases, the outlines of the internal and external threads may collide, which may lead to the building up of excessive mechanical stresses in the fitting material and consequent failure of the fitting.

**⚠ Notice! Do not use chemical sealants or adhesives.**

## Summary of assembly properties for ultraPRESS fittings

Fitting structure		Scope of diameters	pressing profile	Pipe ending treatment method		
				calibration	edge chamfering	
ultraPRESS with colored ring		Color of ring	16	U or TH	No	No
			20		No	No
			25		Recommended	No
			26 <sup>(2)</sup>	U, C or TH <sup>(1)</sup>	Recommended	No
			32	U or TH	Recommended	No
			40		Yes	Yes
ultraPRESS with transparent ring		50	TH	Yes	Yes	
		63		Yes	Yes	

1) jaws name (profile) depends on the manufacturer

2) In 2024 REMS C26 jaws has been renamed into U26. KAN-therm branded jaws dedicated for 26 mm diameter remain C26.

## Performing “press” type connections for KAN-therm ultraPRESS fittings

### Tools

To perform connections in KAN-therm ultraPRESS, use tools available in KAN-therm system offer - see the table below.

Manufacturer	Press type		Diameter [mm]	Jaws/collars		Adapter	
	Description	Code		Description	Code	Description	Code
KAN-therm	AC 3000 DC 4000	1936267239 1936267238	16	U	1936267257	-	-
			16	TH	1936267241	-	-
			20	U	1936267258	-	-
			20	TH	1936267242	-	-
			25	U	1936267259	-	-
			25	TH	1936267271	-	-
			26	C	1936267245	-	-
			26	TH	1936267243	-	-
			32	U	1936267260	-	-
			32	TH	1936267244	-	-
			40	U	1936267261	-	-
			40	TH	1936267272	-	-

Manufacturer	Press type		Diameter [mm]	Jaws/collars		Adapter				
	Description	Code		Description	Code	Description	Code			
NOVOPRESS NOVOPRESS	ACO203XL EFP203	1948267181 1948267210	16	U	1936267232	-	-			
			16	TH	1936267223	-	-			
			20	U	1936267233	-	-			
			20	TH	1936267224	-	-			
			25	U	1936267234	-	-			
			25	TH	1936267225	-	-			
			14	U <sup>3)</sup>	1936267231	-	-			
			14	TH <sup>3)</sup>	1936267222	-	-			
			26	TH	1936267226	-	-			
			32	U	1936267235	-	-			
			32	TH	1936267227	-	-			
			40	U	1936267236	-	-			
			40	TH	1936267228	-	-			
			50	[OP]TH	1936267229	ZB203	1948267000			
	63	[OP]TH	1936267230							
	ACO103	1936055004 - "U" 1936055005 - "TH"	16	U	1936267113	-	-			
			16	TH	1936267108	-	-			
			20	U	1936267114	-	-			
			20	TH	1936267109	-	-			
			25	U	1936267115	-	-			
			25	TH	1936121003	-	-			
			26	TH	1936267110	-	-			
			32	U	1936267116	-	-			
			32	TH	1936267111	-	-			
			14	U <sup>3)</sup>	1936267220	-	-			
			14	TH <sup>3)</sup>	1948267107	-	-			
REMS			Power-Press SE Akku-Press Power-Press ACC Eco Press <sup>1)</sup>	1936267160 1936267152 1936267219 1936267174 <sup>1)</sup>	16 <sup>1)</sup>	U	1936267122	-	-	
	16 <sup>1)</sup>	TH			1948267109	-	-			
	20 <sup>1)</sup>	U			1936267125	-	-			
	20 <sup>1)</sup>	TH			1948267114	-	-			
	25 <sup>1)</sup>	U			1936267127	-	-			
	25 <sup>1)</sup>	TH			1948267116	-	-			
	26 <sup>1)</sup>	U <sup>2)</sup>			1936267130	-	-			
	26 <sup>1)</sup>	TH			1936267101	-	-			
	32	U			1936267137	-	-			
	32	TH			1936267103	-	-			
	40	U			1936267139	-	-			
	40	TH			1936267105	-	-			
	50	TH			1936267134	-	-			
	63	TH			1936267136	-	-			
	KLAUKE	KAN-therm Mini			1936055008	16	U	1936267273	-	-
						16	TH	1936055015	-	-
20			U	1936267274		-	-			
20			TH	1936055016		-	-			
25			U	1936267275		-	-			
26			U	1936267276		-	-			
26			TH	1936055014		-	-			
32			U	1936267277		-	-			
32	TH	1936055017	-	-						

<sup>1)</sup> From 2024, by decision of the REMS tool manufacturer, the C 26 jaw was renamed the U 26 jaw.

<sup>2)</sup> Limited diameter range - use selected press jaws

<sup>3)</sup> Tools for installation of ultraPRESS 14x2 connector - KAN-therm Surface heating and cooling

To perform a connections in KAN-therm ultraPRESS, other tools available on the market can also be utilized - see the table below.

Size	Manufacturer	Press machine	Jaws/collars	Press profile
16–40 mm	Novopress	Comfort – Line ACO 102 Basic – Line AFP 101	16–40 mm PB1 jaws	
16–63 mm	Novopress	Comfort – Line ECO 202 Comfort – Line ACO 202 Basic – Line EFP 202 Basic – Line AFP 202 Basic – Line EFP 2 adapter ZB 201 adapter ZB 203	16–40 mm PB2 jaws 50–63 mm jaws for adapters	Ø 16–40 mm – U, TH profile Ø 50–63 mm – TH profile
16–20 mm	Klauke	MP20	16–20 mm inserts	
16–32 mm	Klauke	i-press mini MAP2L mini MAP1 AHP700LS PKMAP2 HPU32 MP32	16–32 mm mini jaws 16–32 mm jaws for mini inserts 16–32 mm inserts	Ø 16–40 mm – U profile Ø 16–32 mm – TH profile Ø 63 mm – TH profile  <b>Notice:</b> Ø 40–50 mm TH profile (KSP 11) – non-compatible with the KAN-therm system
16–63 mm	Klauke	i-press medium UAP3L UAP2 UNP2 i-press medium UAP4L HPU2 AHP700LS PKUAP3 PKUAP4	16–40 mm tongs 16–32 mm tongs for inserts 40–63 mm tongs for inserts	
16-40 mm	HILTI	NPR 019 IE-A22 NPR 19-22	NPR PM jaws 16-40 mm	16-32 mm - U, TH profile 40 mm - U profile
16-40 mm, 63 mm	HILTI	NPR 032 IE-A22 NPR 32-22 NPR 32 P-22	NPR PS jaws 16-50 mm NPR PR jaws 40-63 mm	16-32 mm – U, TH profile 40 mm – U profile 63 mm – TH profile
16-40 mm, 63 mm	HILTI	NPR 032 PE-A22 NPR 32 XL-22	NPR-PS jaws 16-40 mm NPR PR jaws 63 mm	16-32 mm – U, TH profile 40 mm – U profile 63 mm – TH profile
16–40 mm	REMS	Mini-Press ACC	16–40 mm mini tongs	Ø 16–40 mm – U, TH profile
16–63 mm	REMS	Power-Press E Power-Press 2000 Akku-Press ACC	16–63 mm tongs	Ø 50–63 mm – TH profile
16–40 mm	Rothenberger	Standard Romax 4000 Compact Romax AC/Akku Standard Romax 3000 Akku Romax 3000 AC Romax AC ECO	ONLY KAN-therm jaws	Ø 16–40 mm – profil TH Ø 16–40 mm – profil U

Tools offered by the KAN company available as single elements or in complete sets..

**KAN-therm tools:**

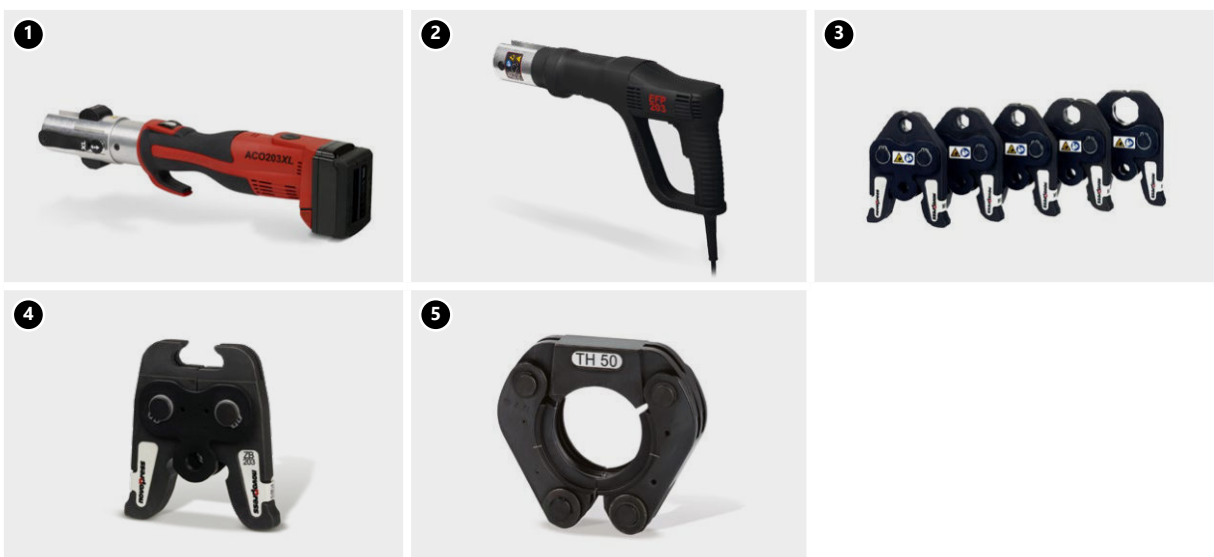


1. Electric press KAN-therm AC 3000
2. Battery-powered press KAN-therm DC 4000
3. „U“ KAN-therm jaws
4. „TH“ KAN-therm jaws
5. „C“ KAN-therm jaws

**NOVOPRESS tools:**



1. Battery-powered press ACO103
2. PB1 14–32 mm jaws



1. Battery-powered press ACO203XL
2. Electric press EFP203
3. PB2 16–40 mm jaws
4. Adapter ZB203 (50 and 63)
5. Snap On 50 and 63 mm collars

## REMS tools:



1. Electric press Power-Press ACC
2. Battery-powered press Akku-Press
3. Electric press Power-Press SE
4. Manual press tool Eco-Press (16–25(26) mm)
5. 16–40 mm jaws
6. 50–63 mm jaws

## KLAUKE tools:



1. Battery-powered press KAN-therm Mini
2. SBM U 16–32 mm jaws
3. SBM TH 16–32 mm jaws

**! Notice**

Depending on the structure of the KAN-therm ultraPRESS fitting and its diameter, the following jaw profiles must be used for pressing:

**KAN-therm ultraPRESS fittings:**

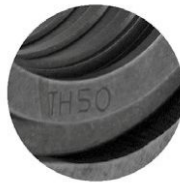
- „U” or „TH” profile for diameters 16-40 mm.

**KAN-therm ultraPRESS fittings:**

- „TH” profile – for diameters: 50 and 63 mm.



U profile

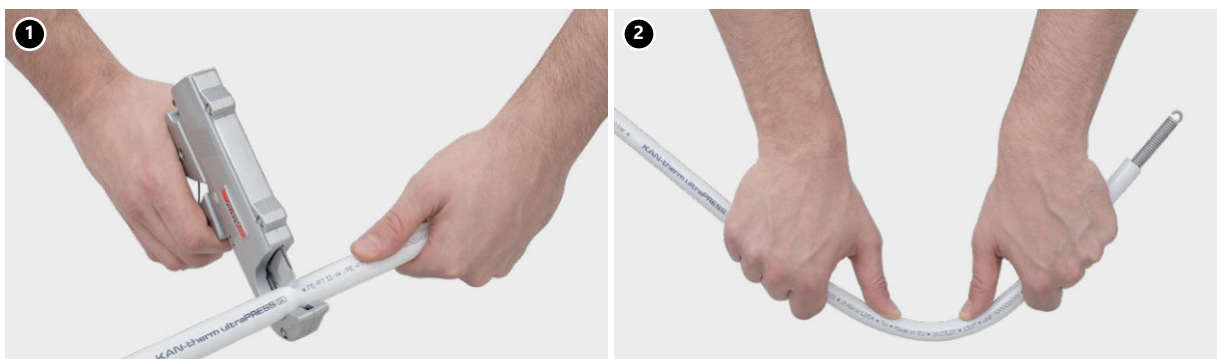


TH profile

**! Tools – work safety**

Before starting any works, make sure you read the instruction manual and learn the principles of safe work. All tools must be used according to their dedication and the manufacturer's instruction manual. During the use of tools, one must observe the terms of regular inspections and all applicable safety regulations. Using tools against their designed use may lead to their damage or to the damage of accessories and pipes. It may also lead to the occurrence of leakages in installation joints.

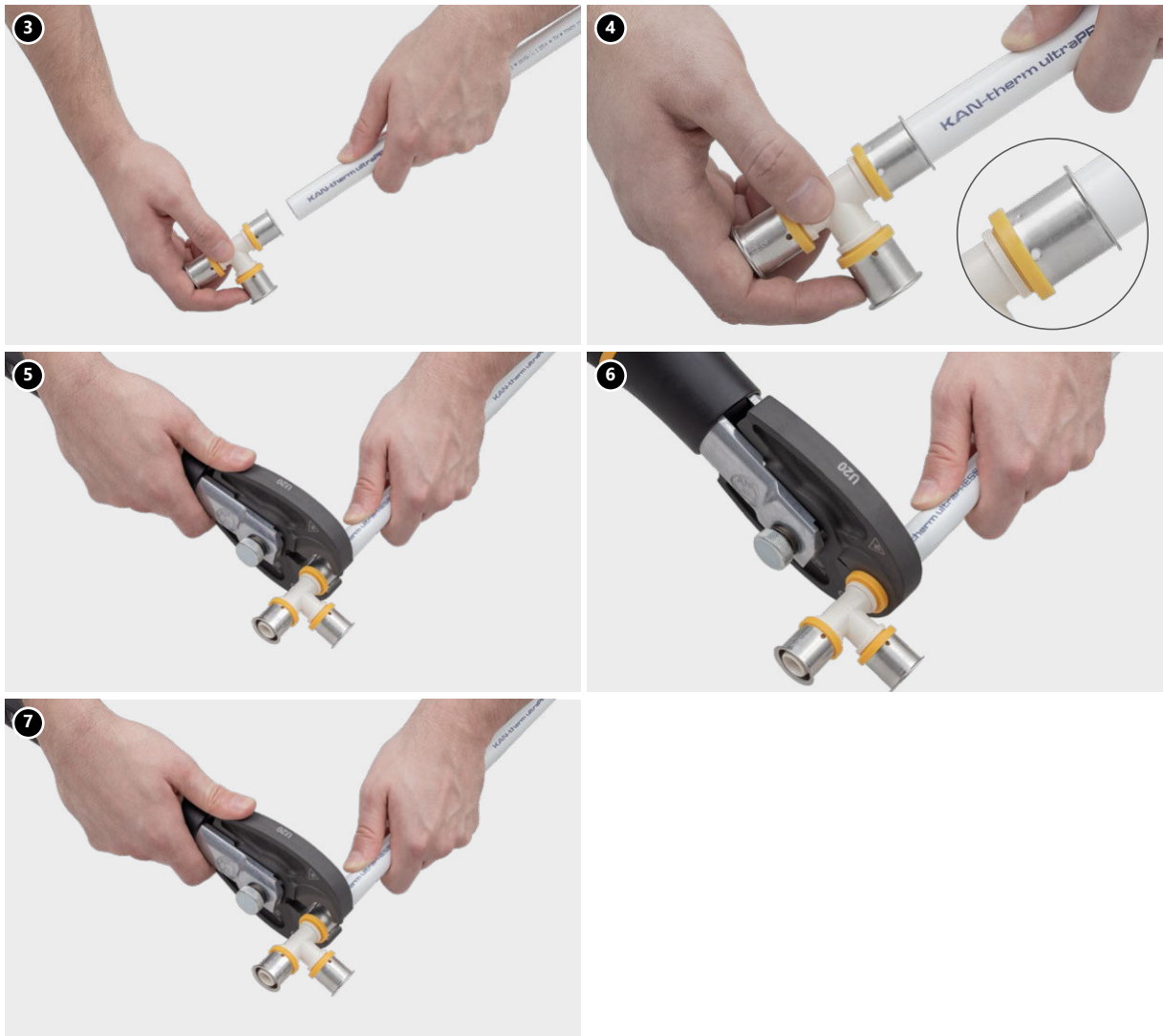
**Assembly of KAN-therm ultraPRESS fittings with diameters: 16, 20, 25, 26, 32 and 40 mm**



1. Using a pipe cutter for PERTAL pipes or a pipe roller cutter, cut the pipe perpendicularly to its axis at the required length.  
**Notice! Use only sharp, non-chipped cutting tools.**
2. Give the pipe its desired shape. Bend the pipe using an inner or outer spring. Observe the minimum radius  $R > 5 De$  requirement. When using mechanic pipe benders for diameters 16 – 20 mm, the minimum radius is  $R > 3,5 De$ . Execute all bends at a distance of  $10 \times De$  from the nearest joint.

In the case of KAN-therm ultraPRESS fittings, (16-32 mm) pipe endings do need not to be chamfered, provided that sharp cutting tools are used and that the pipe is mounted using a proper shape fitting. For bigger diameters (25 and more), we suggest the use of a calibrator to allow the pipe to slide easily onto the stub.

The calibration of the pipe is obligatory for 40 mm diameter.



3. Slide the pipe into the fitting until it stops – axis mount of the pipe on the stub of the fitting is required. Check the depth of the fit – the edge of the pipe must be visible in inspection holes.
4. Check the pipe insertion depth - control holes in steel sleeve should be completely covered by the pipe slid in the fitting.
5. Place the jaws precisely on the stainless steel sleeve between the plastic ring and the collar of the sleeve, perpendicularly to the axis of the stub ("U" type profile). In the case of the "TH" profile, the jaws are positioned on the plastic ring (the ring must be embraced by the external groove of the jaw). In both cases, the structure of the joint makes it impossible for the jaws to slide off in the process of pressing.
6. Start the drive of the press machine and perform the connection. The process of pressing ends when the jaws of the tool completely close on the joint. Fitting may be pressed on a pipe only once.
7. Unlock the jaws and remove the tool from the fitting. The joint is ready for a pressure test

**!** **Notice**

„Press“ type joints should be executed above ambient temperature of 0 °C. Before starting any works, read the instruction manuals for all tools and learn the principles of safe work.



## Assembly of KAN-therm ultraPRESS fittings with diameters 50 and 63 mm



1. Using a pipe cutter for PERTAL pipes or a pipe roller cutter, cut the pipe perpendicularly to its axis at the required length.
2. Calibrate the pipe and chamfer its inner edge using a calibrator. The aluminum layer should remain intact. The edge of the pipe must not have any chips or splinters.
3. Slide the pipe into the fitting until it stops. Check the depth of the joint – the inspection holes must be completely covered by the pipe.
4. Check the pipe insertion depth - control holes in steel sleeve should be completely covered by the pipe slid in the fitting.
5. Place the jaws perpendicularly on the stainless steel sleeve so the jaws are positioned on the transparent plastic ring (the ring must be embraced by the external groove of the jaw). The structure of the joint makes it impossible for the jaws to slide off in the process of pressing.
6. Place the jaw of the press tool on the sleeve so that it contacts the flange of the fitting. The outer edge of the jaw should be pushed against, but not encompass, the fittings flange\*. Start the press drive and make the connection. The pressing process continues until the jaws of the tool are completely closed. Pressing the sleeve on the pipe can be done only once.
7. Unlock the jaws and remove the tool from the pressed sleeve. The joint is ready for a pressure test



### Notice

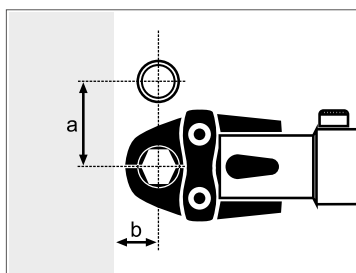
**„Press“ type joints should be executed above ambient temperature of 0 °C. Before starting any works, read the instruction manuals for all tools and learn the principles of safe work.**

\* it concerns old design of the fittings, without transparent base ring.

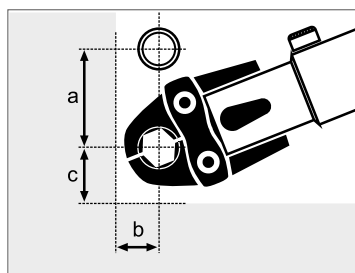
## Bending radius of KAN-therm ultraPRESS PERTAL pipes with aluminum layer

Pipe diameter [mm]	Minimal bending radius $R_{min}$ [mm]	
	Bending without tools ( $R_{min} \geq 5 \times De$ )	Bending with shaping tools ( $R_{min} \geq 3,5 \times De$ )
16 x 2,0	80	56
20 x 2,0	100	70
25 x 2,5	125	88
26 x 3,0	130	91
32 x 3,0	-	112
40 x 3,5	-	140
50 x 4,0	-	175
63 x 4,5	-	221

## Minimum assembly distances



Rys. 1



Rys. 2

Ø [mm]	Pic. 1		Pic. 2		
	a [mm]	b [mm]	a [mm]	b [mm]	c [mm]
16	42	16	58	19	31
20	46	18	58	20	34
25 / 26	53	21	62	23	37
32	62	27	67	27	45
40	72	31	77	31	51
50	100	67	100	67	70
63	128	90	128	100	88

Above table gives indication for REMS 2-segment jaws (16-40 mm) and REMS 4-segment jaws (50-63 mm).

## Threaded joints for PERTAL pipes with aluminum layer

Threaded joints for multilayer KAN-therm pipes are executed using two types of fittings:

- "barrel" union adapter (inlet connection),
- eurocone adapter with compression ring.

### Threaded fittings (inlet connections)

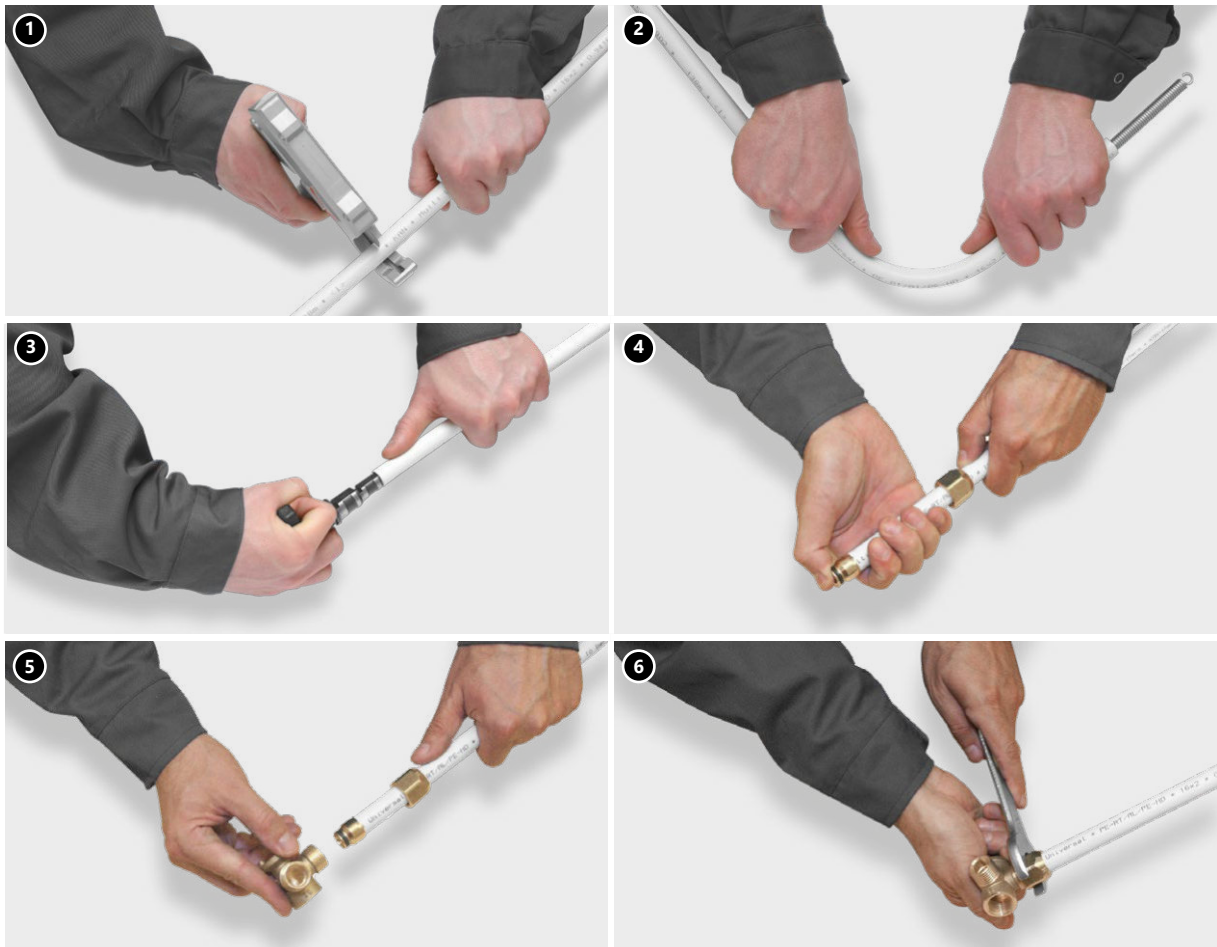
Fittings of this type are made of brass. Each fitting consists of a body with a stub equipped with two O-Rings (used for fitting pipe ends) and a sealing cone (Eurocone type), as well as a threaded nut. Such joints are compatible with KAN-therm brass fittings with male threads, such as elbows, tees, tap connections with specially formed sockets (for sealing cone threads with O-Rings).

Dimensions of nut threads:

- 1/2" - for diameters 14 and 16,
- 3/4" - for diameters 14, 16 and 20,
- 1" - for diameters 20, 25 and 26.



1. Connection adapter (inlet connection)
2. Fittings with male threads



1. Using a pipe cutter for PERTAL pipes or a pipe roller cutter, cut the pipe perpendicularly to its axis at the required length.
2. Give the pipe its desired shape. Bend the pipe using an inner or outer spring. Observe the minimum radius  $R > 5 De$  requirement. When using mechanic pipe benders for diameters 16–20 mm, the minimum radius is  $R > 3,5 De$ . Execute all bends at a distance of  $10 \times De$  from the nearest joint.
3. Calibrate the pipe and chamfer its inner edge using a calibrator. The aluminum layer should remain intact. The edge of the pipe must not have any chips or splinters.
4. Slide the nut onto the pipe. Slide the stub of the fitting into the pipe until it clearly stops. The depth of the joint is c.a. 9 mm for pipes of 16, 20 mm in diameter and 12 mm for pipes of 25 (26) mm in diameter.
5. Slide the fitting and the pipe into the socket of the male fitting until it clearly stops.
6. Screw the nut on the fitting using a wrench.

**!** Particular attention should be paid to the precise placement of the fitting in the socket and tightening the nut. When modernizing an installation, it is possible to disassemble the joint (cut off the used pipe ending). There is, however, no possibility of reusing the inlet connection. Do not place such joints in flooring screeds. They must be located in easily accessible places.

## Eurocone adapters

Fittings of this type are made of brass or brass and PPSU. Each fitting consists of a body with a stub equipped with an O-Ring (used for mounting pipe ends), a compression ring and a threaded nut. Such fittings are compatible with KAN-therm brass fittings with male threads, such as elbows, tees, tap connections (9012 series) with specially formed sockets.



1. Universal brass eurocone adapter for KAN-therm system pipes.
2. Eurocone adapter with compression ring for PERT, PEXC and bluePERT pipes.
3. PPSU universal eurocone adapter for KAN-therm pipes.

Mounting the pipe on the stub is performed in an identical way as in the case of the threaded joint (inlet connection) described above. Remember to slide on the compression ring after applying the nut. Then, remember to move the ring towards the edge of the pipe before screwing in the nut. The diameters of pipes connected and corresponding nut dimensions are:  $\text{Ø}16 \text{ G}1/2"$ ,  $\text{Ø}16 \text{ G}3/4"$ ,  $\text{Ø}20 \text{ G}3/4"$  (for PERTAL and bluePERTAL pipes) and  $\text{Ø}16 \text{ G}3/4"$ ,  $\text{Ø}20 \text{ G}3/4"$  (for PERT, PEXC and bluePERT pipes).

**i** **When modernizing an installation, it is possible to disassemble the joint (cut off the used pipe ending). There is also a possibility of reusing the eurocone adapter (provided that the ring is replaced with a new one).**

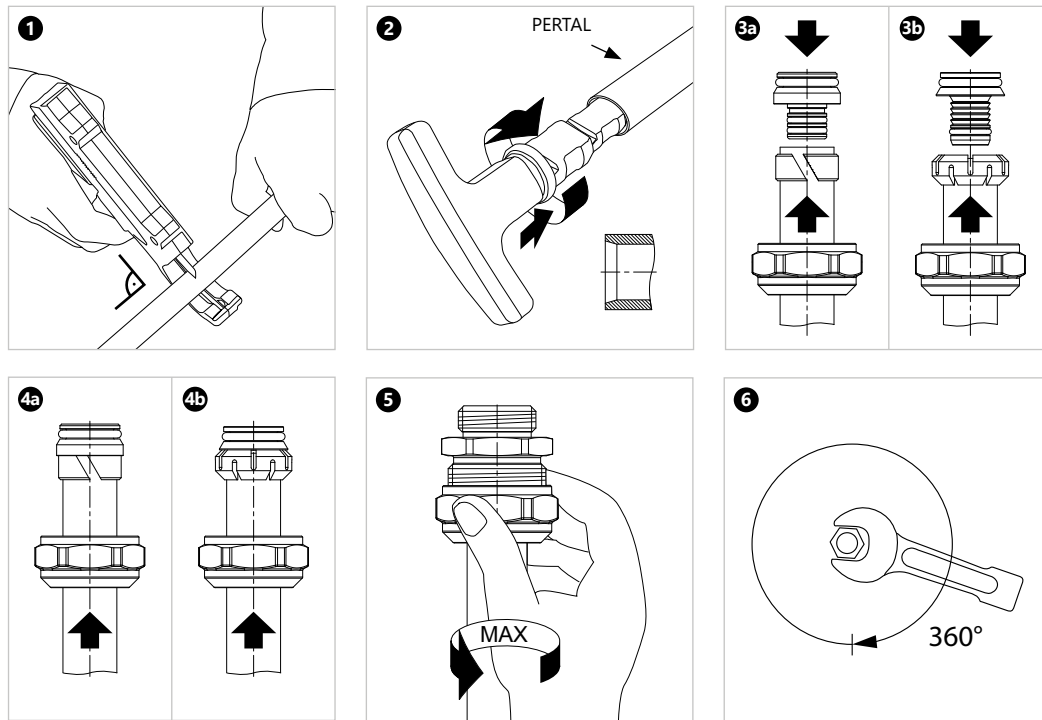
All above mentioned eurocone adapters are compatible with:

- a series of KAN-therm fittings with male threads equipped with Eurocone sockets,
- KAN-therm manifolds equipped with special  $1/2"$  and  $3/4"$  nipples.

To connect  $16 \times 2$  mm PERTAL pipes directly to the manifold body (without nipples), use a pressed fitting with a compression ring with  $1/2"$  male thread. The thread is equipped with an O-Ring, making additional sealants redundant.



Fitting with  $1/2"$  male thread for connecting of  $16 \times 2$  pipes to manifolds.



## 1.4 Transport and storage

The elements of KAN-therm ultraPRESS system can be stored in temperatures below 0 °C. If that is a case, secure them against dynamic loads.

They should be protected against mechanical damage during transport. Due to the sensitivity to ultraviolet rays, the pipes should be protected against direct long-term exposure to sunlight, both during storage, transport and assembly. KAN-therm ultraPRESS system elements should be transported by covered means of transport and stored in standard storage facilities in conditions which do not cause deterioration of their quality.

- Do not store in the immediate vicinity of chemicals and sources of ammonia (toilets),
- Do not expose to sunlight (protect from heat and UV radiation),
- Avoid storing near strong heat sources,
- During storage and transport, no contact with sharp objects is allowed,
- Avoid surfaces with sharp edges or loose sharp elements on their surface,
- Do not drag directly on the ground or concrete surface,
- Protect against dirt, mortar, oils, greases, paints, solvents, moisture chemicals, etc.,
- Store and transport in original packaging,
- Remove elements from their original packaging immediately before assembly.



Detailed information about storage and transport of components can be found at [en.kan-therm.com](http://en.kan-therm.com).





# SYSTEM KAN-therm ultraPRESS - assortment

## Pipes

### PERTAL pipe - coil

GROUP: B

Size [mm]	*	Code			UM
16×2,0		1029196031	600	2400	m
16×2,0		1029196123	200	3000	m
20×2,0		1029196092	100	1500	m
25×2,5		1029196081	50	750	m
26×3,0		1029196106	50	750	m
32×3,0		1029196115	50	600	m
40×3,5		1029196119	25	300	m



**Note:**

Application class (acc. to ISO 10508) 1-5; 10 bar.



### PERTAL pipe - bar

GROUP: B

Size [mm]	*	Code			UM
16×2,0		1029196210	5	50	m
20×2,0		1029196211	5	35	m
25×2,5		1029196212	5	40	m
32×3,0		1029196071	5	40	m
40×3,5		1029196078	5	25	m
50×4,0		1029196274	5	15	m
63×4,5		1029196275	5	5	m

**Note:**



Application class (acc. to ISO 10508) 1-5; 10 bar.



### PERTAL pipe in red insulation 6 mm - coil

GROUP: B

N

Size [mm]	*	Code			UM
16×2,0		1029195010	50	750	m
16×2,0		1029196208	100	900	m
20×2,0		1029195000	50	750	m
25×2,5		1029195002	25	375	m
32×3,0		1029196114	50	300	m

**Note:**


Application class (acc. to ISO 10508) 1-5; 10 bar.



### PERTAL pipe in blue insulation 6 mm - coil

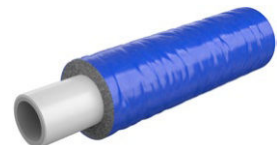
GROUP: B

N

Size [mm]	*	Code			UM
16×2,0		1029195011	50	750	m
16×2,0		1029196209	100	900	m
20×2,0		1029195001	50	750	m
25×2,5		1029195003	25	375	m
32×3,0		1029196067	50	300	m

**Note:**

Application class (acc. to ISO 10508) 1-5; 10 bar.



 coil  bar  pipes in tube  bag  carton box  pallet **N** new  available soon

\* custom-made - lead time max 4 weeks | \*\* availability as agreed | \*\*\* while stock lasts

## Connectors



### Brass female connector

GROUP: F

Size [mm]	*	Code			UM
16 Rp1/2"		1009044002	10	120	pc.
20 Rp1/2"		1009042120	10	120	pc.
20 Rp3/4"		1009044003	10	80	pc.
25 Rp3/4"		1009044024	5	50	pc.
25 Rp1"		1009044005	5	40	pc.
26 Rp3/4"		1009044029	5	50	pc.
26 Rp1"		1009044006	5	40	pc.
32 Rp1"		1009044040	5	40	pc.
32 Rp1 1/4"		1009044008	5	40	pc.
40 Rp1"		1009044051	2	20	pc.
40 Rp1 1/4"		1009044050	2	20	pc.
40 Rp1 1/2"		1009044009	2	20	pc.



### Brass male connector

GROUP: F

Size [mm]	*	Code			UM
16 R1/2"		1009045005	10	150	pc.
20 R1/2"		1009045009	10	120	pc.
20 R3/4"		1009042128	10	120	pc.
25 R1/2"		1009042132	5	50	pc.
25 R3/4"		1009045014	5	50	pc.
25 R1"		1009045013	5	50	pc.
26 R1/2"		1009042134	5	50	pc.
26 R3/4"		1009045043	5	50	pc.
26 R1"		1009045015	5	50	pc.
32 R1"		1009045017	5	40	pc.
32 R1 1/4"		1009045016	5	40	pc.
40 R1"		1009045061	2	20	pc.
40 R1 1/4"		1009045019	2	20	pc.
40 R1 1/2"		1009045018	2	20	pc.
50 R1 1/2"		1009045020	2	20	pc.
63 R2"		1009045003	1	10	pc.



### PPSU female connector

GROUP: F

Size [mm]	*	Code			UM
16 Rp1/2"	***	1009044030	10	120	pc.



coil 
 bar 
 pipes in tube 
 bag 
 carton box 
 pallet 
 new 
 available soon

\* custom-made - lead time max 4 weeks | \*\* availability as agreed | \*\*\* while stock lasts



## Brass connector Compression

GROUP: F

Size [mm]	*	Code			UM
16 / 15		1009042077	10	150	pc.
22 / 20		1009042079	10	80	pc.
25 / 22		1009042082	5	50	pc.



**Note:**

The coupling can work with metal press systems such as KAN-therm Steel, KAN-therm Inox or KAN-therm Copper.



## Brass elbow Compression

GROUP: F

Size [mm]	*	Code			UM
16 / 15	*	1009068018	10	120	pc.



**Note:**

The coupling can work with metal press systems such as KAN-therm Steel, KAN-therm Inox or KAN-therm Copper.



## Brass coupling ultraPRESS/Push



GROUP: F

Size [mm]	*	Code			UM
16 / 14x2,0		1009042146	10	150	pc.
16 / 18x2,0		1009042149	10	150	pc.
16 / 18x2,5		1009042145	10	150	pc.



## Brass coupling



GROUP: F

Size [mm]	*	Code			UM
16		1009042042	10	150	pc.
20		1009042049	10	120	pc.
25		1009042055	5	70	pc.
32		1009042003	5	40	pc.
40		1009042004	2	20	pc.
50		1009042005	2	20	pc.
63		1009042022	1	5	pc.



## PPSU coupling

GROUP: F

Size [mm]	*	Code			UM
16		1009042013	10	160	pc.
20		1009042015	10	150	pc.
25		1009042017	5	60	pc.
26		1009042039	5	60	pc.





### Brass reducing coupling

GROUP: F

Size [mm]	*	Code			UM
20 / 16		1009042105	10	120	pc.
25 / 16		1009042111	5	70	pc.
25 / 20		1009042117	5	70	pc.
32 / 16		1009046075	5	40	pc.
32 / 20		1009046072	5	40	pc.
32 / 25		1009046018	5	40	pc.
32 / 26		1009046046	5	40	pc.
40 / 20		1009046047	2	30	pc.
40 / 25		1009046052	2	30	pc.
40 / 26		1009046054	2	30	pc.
40 / 32		1009046048	2	20	pc.
50 / 32		1009046002	2	20	pc.
50 / 40		1009046004	2	20	pc.
63 / 40		1009046007	1	10	pc.
63 / 50		1009046008	1	10	pc.



### PPSU reducing coupling

GROUP: F

Size [mm]	*	Code			UM
20 / 16		1009046026	10	120	pc.
25 / 16		1009046029	5	70	pc.
25 / 20		1009046032	5	70	pc.
26 / 16		1009046040	5	70	pc.
26 / 20		1009046045	5	70	pc.



### Brass female tee

GROUP: F



Size [mm]	*	Code			UM
16 Rp $\frac{1}{2}$ "		1009258000	5	60	pc.
20 Rp $\frac{1}{2}$ "		1009258001	5	50	pc.
20 Rp $\frac{3}{4}$ "		1009258011	5	50	pc.
25 Rp $\frac{1}{2}$ "		1009258029	2	30	pc.
25 Rp $\frac{3}{4}$ "		1009258002	2	30	pc.
26 Rp $\frac{1}{2}$ "		1009258034	2	30	pc.
26 Rp $\frac{3}{4}$ "		1009258036	2	30	pc.
32 Rp $\frac{1}{2}$ "		1009257279	2	20	pc.
32 Rp $\frac{3}{4}$ "		1009257262	2	20	pc.

coil 
 bar 
 pipes in tube 
 bag 
 carton box 
 pallet 
 new 
 available soon

\* custom-made - lead time max 4 weeks | \*\* availability as agreed | \*\*\* while stock lasts

### Brass male tee



GROUP: F

Size [mm]	*	Code			UM
16 R1/2"		1009259000	5	60	pc.
20 R1/2"		1009259027	5	30	pc.
20 R3/4"		1009259001	5	50	pc.
25 R3/4"		1009259037	2	30	pc.
25 R1"		1009259002	2	30	pc.
26 R3/4"		1009259043	2	30	pc.
26 R1"		1009259040	2	30	pc.
32 R1"		1009259046	2	20	pc.
40 R1"		1009259003	1	10	pc.
50 G1"	**	1009259006	1	12	pc.
63 G1"	**	1009259010	1	5	pc.



### Brass tee



GROUP: F

Size [mm]	*	Code			UM
16		1009257129	10	80	pc.
20		1009257144	5	50	pc.
25		1009257152	2	30	pc.
<b>N</b> 32		1009257305	2	20	pc.



### PPSU tee

GROUP: F

Size [mm]	*	Code			UM
16		1009257007	10	80	pc.
20		1009257009	5	50	pc.
25		1009257010	2	30	pc.
26		1009257016	2	30	pc.
32		1009257020	2	20	pc.
40		1009257023	1	10	pc.
50		1009257027	1	6	pc.
63		1009257029	1	3	pc.



 coil 
  bar 
  pipes in tube 
  bag 
  carton box 
  pallet 
 **N** new 
  available soon

\* custom-made - lead time max 4 weeks | \*\* availability as agreed | \*\*\* while stock lasts



## Brass reducing tee

GROUP: F





Size [mm]	*	Code			UM
20 / 16 / 16		1009257205	5	60	pc.
20 / 16 / 20		1009260167	5	50	pc.
20 / 20 / 16		1009257217	5	50	pc.
20 / 25 / 20		1009260164	2	30	pc.
25 / 16 / 20		1009260160	5	50	pc.
25 / 16 / 25		1009260161	2	30	pc.
25 / 20 / 16		1009260166	5	50	pc.
25 / 20 / 20		1009260162	2	30	pc.
25 / 20 / 25		1009260163	2	30	pc.
25 / 25 / 20		1009260165	2	30	pc.
<b>N</b> 32 / 20 / 32		1009260294	2	20	pc.
<b>N</b> 32 / 25 / 25		1009260296	2	20	pc.
<b>N</b> 32 / 25 / 32		1009260295	2	20	pc.
50 / 20 / 50		1009260168	1	10	pc.
50 / 25 / 40		1009260172	1	10	pc.
50 / 25 / 50		1009260169	1	10	pc.
50 / 26 / 40		1009260182	1	10	pc.
50 / 26 / 50		1009260069	1	10	pc.
50 / 32 / 40		1009260170	1	10	pc.
50 / 32 / 50		1009260171	1	10	pc.
50 / 40 / 40		1009260174	1	10	pc.
50 / 40 / 50		1009260173	1	8	pc.
63 / 20 / 63		1009260175	-	5	pc.
63 / 25 / 63		1009260176	-	5	pc.
63 / 26 / 63		1009260183	-	5	pc.
63 / 32 / 50		1009260177	-	5	pc.
63 / 32 / 63		1009260178	-	5	pc.
63 / 40 / 50		1009260179	1	5	pc.
63 / 40 / 63		1009260097	-	5	pc.
63 / 50 / 50		1009260181	1	5	pc.
63 / 50 / 63		1009260180	1	5	pc.

 coil 
  bar 
  pipes in tube 
  bag 
  carton box 
  pallet 
 **N** new 
  available soon

\* custom-made - lead time max 4 weeks | \*\* availability as agreed | \*\*\* while stock lasts

## PPSU reducing tee

GROUP: F

Size [mm]	*	Code					UM
16 / 20 / 16		1009260189	5	60	pc.		
20 / 16 / 16		1009260184	5	60	pc.		
20 / 16 / 20		1009260185	5	50	pc.		
20 / 20 / 16		1009260188	5	50	pc.		
20 / 25 / 20		1009260190	2	30	pc.		
20 / 26 / 20		1009260007	2	30	pc.		
25 / 16 / 20		1009260186	5	50	pc.		
25 / 16 / 25		1009260187	2	30	pc.		
25 / 20 / 16		1009257106	5	50	pc.		
25 / 20 / 20		1009260010	2	30	pc.		
25 / 20 / 25		1009260000	2	30	pc.		
25 / 25 / 20		1009260009	2	30	pc.		
25 / 32 / 25		1009257063	2	20	pc.		
26 / 16 / 20		1009257014	5	50	pc.		
26 / 16 / 26		1009257015	2	30	pc.		
26 / 20 / 16		1009257113	5	50	pc.		
26 / 20 / 20		1009260019	2	30	pc.		
26 / 20 / 26		1009260022	2	30	pc.		
26 / 26 / 20		1009260026	2	30	pc.		
26 / 32 / 26		1009257066	2	20	pc.		
32 / 16 / 32		1009260191	2	20	pc.		
32 / 20 / 25		1009260027	2	20	pc.		
32 / 20 / 26		1009257021	2	20	pc.		
32 / 20 / 32		1009260192	2	20	pc.		
32 / 25 / 25		1009260032	2	20	pc.		
32 / 25 / 32		1009260035	2	20	pc.		
32 / 26 / 26		1009260038	2	20	pc.		
32 / 26 / 32		1009260129	2	20	pc.		
32 / 32 / 20		1009260102	2	20	pc.		
32 / 32 / 25		1009257073	2	20	pc.		
32 / 32 / 26		1009257076	2	20	pc.		
40 / 20 / 32		1009260041	1	12	pc.		
40 / 20 / 40		1009260042	2	12	pc.		
40 / 25 / 32		1009260043	2	12	pc.		
40 / 25 / 40		1009260044	2	12	pc.		
40 / 26 / 32		1009260001	2	12	pc.		
40 / 26 / 40		1009260045	2	12	pc.		
40 / 32 / 32		1009260048	2	12	pc.		
40 / 32 / 40		1009260193	1	10	pc.		
40 / 40 / 32		1009260049	1	10	pc.		



 coil 
  bar 
  pipes in tube 
  bag 
  carton box 
  pallet 
  new 
  available soon

\* custom-made - lead time max 4 weeks | \*\* availability as agreed | \*\*\* while stock lasts

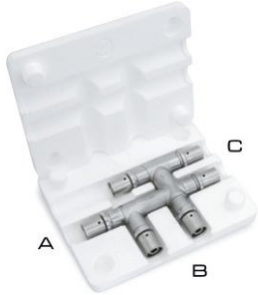


### Nickel-plated brass crossover tee

GROUP: F

Size [mm]	*	Code			UM
16		1009257043	1	4	pc.
20		1009257045	1	4	pc.

**Note:**  
 Press brass crossover tee - nickel-plated version.  
 Styrofoam box dimensions:  
 height (H) = 150 mm  
 length (L) = 190 mm  
 width (W) = 40 mm



### Nickel-plated brass crossover reducing tee

GROUP: F

Size [mm]	*	Code			UM
16 / 16 / 20		1009257048	1	4	pc.
20 / 16 / 16		1009257044	1	4	pc.
20 / 16 / 20		1009257051	1	4	pc.

**Note:**  
 Press brass crossover tee - nickel-plated version.  
 Styrofoam box dimensions:  
 height (H) = 150 mm  
 length (L) = 190 mm  
 width (W) = 40 mm



### Brass elbow 90°

GROUP: F

Size [mm]	*	Code			UM
16		1009068054	10	120	pc.
20		1009068060	10	80	pc.
25		1009068066	5	40	pc.
<b>N</b> 32		1009068112	2	30	pc.




### PPSU elbow 90°

GROUP: F

Size [mm]	*	Code			UM
16		1009068007	10	120	pc.
20		1009068010	10	80	pc.
25		1009068030	5	40	pc.
26		1009068034	5	40	pc.
32		1009068020	2	30	pc.
40		1009068011	2	20	pc.
50		1009068048	2	10	pc.
63		1009068050	1	4	pc.

### Brass female elbow 90°



GROUP: F

Size [mm]	*	Code			UM
16 Rp½"		1009069005	10	120	pc.
20 Rp½"		1009069008	10	100	pc.
20 Rp¾"		1009069011	5	60	pc.
25 Rp¾"		1009068029	5	30	pc.
25 Rp1"		1009069016	5	30	pc.
26 Rp¾"		1009069018	5	30	pc.
26 Rp1"		1009069020	5	30	pc.
32 Rp1"		1009069022	2	30	pc.
40 Rp1¼"		1009069012	2	20	pc.



### Brass male elbow 90°



GROUP: F

Size [mm]	*	Code			UM
16 R½"		1009068000	10	120	pc.
20 R½"		1009070010	10	100	pc.
20 R¾"		1009070013	10	100	pc.
25 R¾"		1009070005	5	40	pc.
25 R1"		1009070022	5	40	pc.
26 R¾"		1009070026	5	40	pc.
26 R1"		1009070016	5	40	pc.
32 R1"		1009070018	2	30	pc.
40 R1¼"		1009070029	2	20	pc.



### PPSU elbow 45°



GROUP: F

Size [mm]	*	Code			UM
32		1009068003	2	30	pc.
40		1009068028	2	20	pc.
50		1009068040	1	10	pc.
63		1009068041	1	4	pc.



### Brass female directly fixed U type wallplate tee - L = 41 mm

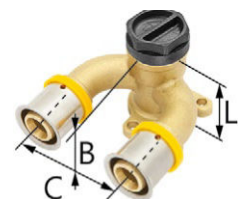
GROUP: F

Size [mm]	*	Code			UM
16 Rp½"		1009285101	5	25	pc.
20 Rp½"		1009285102	5	25	pc.

**Note:**


Size B = 20,5 mm. Stub spacing - 50 mm.

The plastic stop end is intended only for the leak test of the installation.



### Acoustic guard for U type wallplate tee

GROUP: F

Size [mm]	*	Code			UM
16-20		1009183004	5	25	pc.

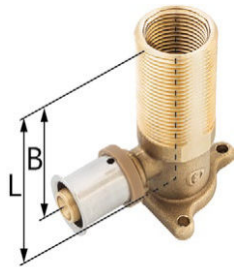




**Brass female/male directly fixed wallplate elbow for drywall,  
L = 78 mm**

**GROUP: F**

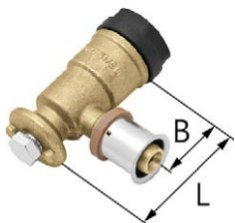
Size [mm]	*	Code			UM
16 Rp1/2"		1009285029	2	20	pc.
Size B = 57 mm.					



**Brass female/male directly fixed wallplate elbow for drywall,  
L = 78 mm**

**GROUP: F**

Size [mm]	*	Code			UM
16 Rp1/2" / G3/4"		1009285055	2	20	pc.
Size B = 57 mm.					

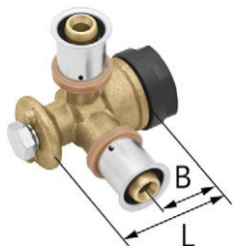


**Brass female wallplate elbow - L = 52,5 mm**

**GROUP: F**

Size [mm]	*	Code			UM
16 Rp1/2"		1009285009	5	40	pc.
20 Rp1/2"		1009285001	5	40	pc.

**Note:**  
Size B = 31,5 mm.  
The wallplate elbow is sold in a set with a mounting bolt and plastic stop end.  
The stop end is intended only for the leak test of the installation.  
It can be used in drywall with metal plates.

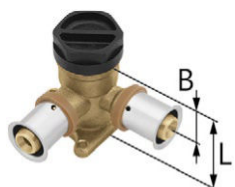


**Brass angular female wallplate tee - L = 41 mm**

**GROUP: F**

Size [mm]	*	Code			UM
16 Rp1/2"		1009285017	5	40	pc.
20 Rp1/2"		1009285040	5	40	pc.

**Note:**  
Size B = 20 mm.  
The wallplate elbow is sold in a set with a mounting bolt and plastic stop end.  
The stop end is intended only for the leak test of the installation.  
It can be used in drywall with metal plates.



**Brass female directly fixed angular wallplate tee - L = 41 mm**

**GROUP: F**

Size [mm]	*	Code			UM
16 Rp1/2"		1009285077	5	50	pc.
20 Rp1/2"		1009285082	5	40	pc.

**Note:**  
Size B = 20 mm.  
The angular wallplate tee is sold in a set with a mounting bolt and plastic stop end.  
The plastic stop end is intended only for the leak test of the installation.



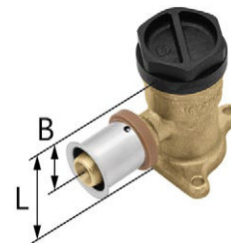
### Brass female directly fixed wallplate elbow - L = 41 mm

GROUP: F

Size [mm]	*	Code			UM
16 Rp $\frac{1}{2}$ "		1009285059	5	50	pc.
20 Rp $\frac{1}{2}$ "		1009285062	5	50	pc.



**Note:**

Size B = 20 mm.  
The wallplate elbow is sold in a set with a plastic stop end.  
The plastic stop end is intended only for the leak test of the installation.



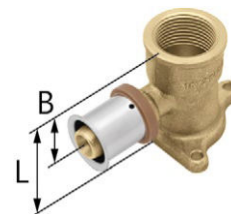
### Brass female directly fixed wallplate elbow - L = 54 mm

GROUP: F

Size [mm]	*	Code			UM
20 Rp $\frac{3}{4}$ "		1009285032	5	50	pc.
25 Rp $\frac{3}{4}$ "		1009285050	2	30	pc.
26 Rp $\frac{3}{4}$ "		1009285053	2	30	pc.

**Note:**

Size B = 30 mm.  
Wallplate elbow is sold without the plastic stop end.






### Acoustic guard for wallplate elbows

GROUP: F

Size [mm]	*	Code			UM
16-20		1009183002	5	25	pc.


**Note:**

Use only with wallplate elbows and tees with a bracket:  
 1009285059  
 1009285062  
 1009285032



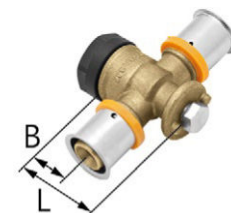
### Brass female straight wallplate tee - L = 41 mm

GROUP: F

Size [mm]	*	Code			UM
20 Rp $\frac{1}{2}$ "		1009285056	5	50	pc.


**Note:**

Size B = 20 mm.  
The straight wallplate tee is sold in a set with a mounting bolt and plastic stop end.  
The plastic stop end is intended only for the leak test of the installation.  
It can be used in drywall with metal plates.



### Brass female directly fixed straight wallplate tee - L = 41 mm

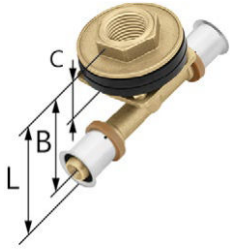
GROUP: F

Size [mm]	*	Code			UM
20 Rp $\frac{1}{2}$ "		1009285057	5	40	pc.

**Note:**

Size B = 20 mm.  
The straight wallplate tee is sold in a set with a mounting bolt and plastic stop end.  
The plastic stop end is intended only for the leak test of the installation.

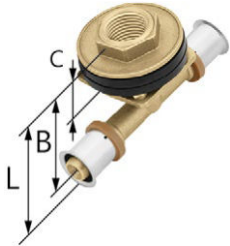




### Brass female drywall tee - L = 53 mm

GROUP: F

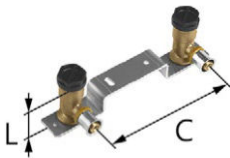
Size [mm]	*	Code			UM
16 Rp1/2"		1009258012	2	20	pc.
20 Rp1/2"		1009258018	2	20	pc.



### Brass female drywall reducing tee - L = 53 mm

GROUP: F

Size [mm]	*	Code			UM
20 / 16 Rp1/2"		1009258017	2	20	pc.



### Brass female wallplate elbow set on mounting plate - L = 44 mm

GROUP: F

Size [mm]	*	Code			UM
16 Rp1/2"		1009285000	1	10	pc.

**Note:**

Plate length = 210 mm.  
 Wallplate elbows are sold in a set with a mounting bolt, plastic stop end and metal plate with crossover.  
 The plastic stop end is intended only for the leak test of the installation.  
 Option to use in drywall.



### Brass nipple coupling

GROUP: F

Size [mm]	*	Code			UM
16 / 12	*	1009042063	20	160	pc.
16 / 15		1009042061	20	160	pc.
22 / 20		1009042064	10	120	pc.
25 / 22		1009042065	5	60	pc.
25 / 28		1009042139	5	60	pc.
26 / 22		1009042141	5	60	pc.
26 / 28		1009042143	5	60	pc.
<b>N</b> 32 / 28		1009042202	5	40	pc.

**Note:**

The coupling can work with metal press systems such as KAN-therm Steel, KAN-therm Inox or KAN-therm Copper.

### Brass tee with Cu Ø15 pipe - L = 300 mm

GROUP: F

Size [mm]	*	Code		UM
16		1009257115	40	pc.
20		1009261004	30	pc.

**Note:**

When connecting radiators via a straight tee, use a set of two tees.

Variants of connecting fittings with nickel-plated pipes with all kinds of appliances are described in the "Designer and Contractor Guidebook".



### Brass reducing tee with Cu Ø15 pipe - L = 300 mm, left

GROUP: F

Size (d2/d1) [mm]	*	Code		UM
20 / 16		1009261001	30	pc.

**Note:**


When connecting radiators with reducing tees, use the set consisting of the left and right tees.

Variants of connecting fittings with nickel-plated pipes with all kinds of appliances are described in the "Designer and Contractor Guidebook".



### Brass reducing tee with Cu Ø15 pipe - L = 300 mm, right

GROUP: F

Size (d1/d2) [mm]	*	Code		UM
20 / 16		1009261002	30	pc.

**Note:**

When connecting radiators with reducing tees, use the set consisting of the left and right tees.

Variants of connecting fittings with nickel-plated pipes with all kinds of appliances are described in the "Designer and Contractor Guidebook".



### Brass tee with Cu Ø15 pipe - L = 750 mm

GROUP: F

Size [mm]	*	Code		UM
16		1009261005	25	pc.
20		1009261009	20	pc.

**Note:**


When connecting radiators via a straight tee, use a set of two tees.

Variants of connecting fittings with nickel-plated pipes with all kinds of appliances are described in the "Designer and Contractor Guidebook".



### Brass reducing tee with Cu Ø15 pipe - L = 750 mm, left

GROUP: F

Size (d2/d1) [mm]	*	Code		UM
20 / 16		1009261000	20	pc.

**Note:**

When connecting radiators with reducing tees, use the set consisting of the left and right tees.

Variants of connecting fittings with nickel-plated pipes with all kinds of appliances are described in the "Designer and Contractor Guidebook".





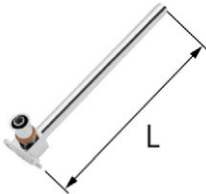
### Brass reducing tee with Cu Ø15 pipe - L = 750 mm, right

GROUP: F

Size (d1/d2) [mm]	*	Code		UM
20 / 16		1009261007	20	pc.

**Note:**

When connecting radiators with reducing tees, use the set consisting of the left and right tees. Variants of connecting fittings with nickel-plated pipes with all kinds of appliances are described in the "Designer and Contractor Guidebook".



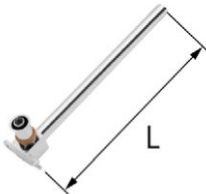
### Brass elbow with Cu Ø15 pipe - L = 210 mm

GROUP: F

Size [mm]	*	Code		UM
16		1009068001	40	pc.


**Note:**

Variants of connecting fittings with nickel-plated pipes with all kinds of appliances are described in the "Designer and Contractor Guidebook".



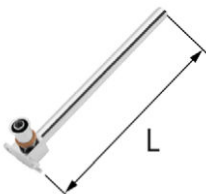
### Brass elbow with Cu Ø15 pipe - L = 300 mm

GROUP: F

Size [mm]	*	Code		UM
16		1009071006	40	pc.


**Note:**

Variants of connecting fittings with nickel-plated pipes with all kinds of appliances are described in the "Designer and Contractor Guidebook".



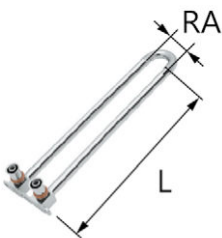
### Brass elbow with Cu Ø15 pipe - L = 750 mm

GROUP: F

Size [mm]	*	Code		UM
16		1009071009	25	pc.


**Note:**

Variants of connecting fittings with nickel-plated pipes with all kinds of appliances are described in the "Designer and Contractor Guidebook".



### Brass double elbow with Cu Ø15 pipe - L = 250 mm

GROUP: F

Size [mm]	*	Code		UM
16		1009068002	15	pc.

**Note:**

Variants of connecting fittings with nickel-plated pipes with all kinds of appliances are described in the "Designer and Contractor Guidebook".

 coil  bar  pipes in tube  bag  carton box  pallet **N** new  available soon

\* custom-made - lead time max 4 weeks | \*\* availability as agreed | \*\*\* while stock lasts

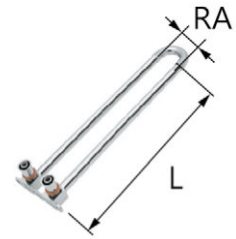
### Brass double elbow with Cu Ø15 pipe - L = 300 mm

GROUP: F

Size [mm]	*	Code			UM
16		1009071014	10	10	pc.



**Note:**

Variants of connecting fittings with nickel-plated pipes with all kinds of appliances are described in the "Designer and Contractor Guidebook".



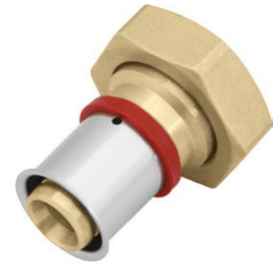
### Brass female half union with flat sealing

GROUP: F

Size [mm]	*	Code			UM
16 G½"		1009105000	10	120	pc.
16 G¾"		1009105002	10	120	pc.
20 G¾"		1009105006	10	80	pc.
20 G1"		1009105004	5	60	pc.
25 G¾"		1009105011	5	60	pc.
25 G1"		1009105009	5	60	pc.
25 G1¼"		1009105008	5	50	pc.
26 G¾"		1009105016	5	60	pc.
26 G1"		1009105014	5	60	pc.
26 G1¼"		1009105013	5	50	pc.
32 G1"		1009105021	5	50	pc.
32 G1¼"		1009105019	5	40	pc.
32 G1½"		1009105018	5	40	pc.
40 G1½"		1009271000	2	30	pc.
40 G2"		1009271002	2	30	pc.

**Note:**

Do not use for connections with manifold nipples.



### Brass female Eurocone adapter



GROUP: F

Size [mm]	*	Code			UM
16 G¾"		1009271013	10	120	pc.
32 G1"		1009271009	5	50	pc.



### Brass stop end

GROUP: F

Size [mm]	*	Code			UM
16		1009250001	10	200	pc.
20		1009250002	10	140	pc.
25		1009250003	5	100	pc.
26		1009250004	5	100	pc.
32		1009250005	5	50	pc.



 coil  bar  pipes in tube  bag  carton box  pallet  new  available soon

\* custom-made - lead time max 4 weeks | \*\* availability as agreed | \*\*\* while stock lasts



### PPSU female universal eurocone adapter

GROUP: A

Size [mm]	*	Code			UM
16 G $\frac{3}{4}$ "		1010271005	10	150	pc.

**Note:**  
The adapter works with PEXC, PERT and PERTAL pipes.



### Brass female universal eurocone adapter

GROUP: A

Size [mm]	*	Code			UM
16 G $\frac{1}{2}$ "		1010271001	10	160	pc.
16 G $\frac{3}{4}$ "		1010271002	10	150	pc.
20 G $\frac{3}{4}$ "		1010271008	10	120	pc.

**Note:**  
Adapters are compatible with fittings for adapter connections, manifolds through manifold nipples.  
The adapter works with PEXC, PERT, PERTAL, bluePERT and bluePERTAL pipes.



### Brass female inlet connection for PERTAL pipes

GROUP: A

Size [mm]	*	Code			UM
16 G $\frac{1}{2}$ "		1010040003	10	160	pc.
16 G $\frac{3}{4}$ "		1010040006	10	120	pc.
20 G $\frac{3}{4}$ "		1010040011	10	120	pc.
25 G1"		1010040013	10	80	pc.

**Note:**  
The above elements are available as nickel-plated on special request (delivery time - 4 weeks).



### Threaded male brass connector for PERTAL pipes

GROUP: A


Size [mm]	*	Code			UM
16x2 G $\frac{1}{2}$ "		1010045000	10	150	pc.
16x2 G $\frac{3}{4}$ "		1010045001	10	150	pc.

**Note:**  
This fitting is adapted for direct screwing into the manifold beam - sealing of the connection in the manifold is done by means of an O-Ring seal.

## Accessories

### Single plastic mounting plate

GROUP: A

	*	Code			UM
		1700210011	10	160	pc.



**Note:**

Total length 59 mm, width 43 mm, depth 8 mm.  
It makes it possible to install wallplate elbows and tees with a bolt or nut on a wall or in wall grooves.  
Do not use in drywall.



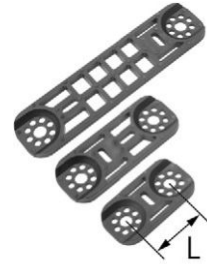
### Double plastic mounting plate

GROUP: A

Spacing (L) [mm]	*	Code			UM
50		1700210008	10	120	pc.
80		1700210010	10	100	pc.
150		1700210006	10	70	pc.



**Note:**

Plate 50 mm - total length 84 mm, width 43 mm, depth 8 mm.  
Plate 80 mm - total length 114 mm, width 43 mm, depth 8 mm.  
Plate 150 mm - total length 184 mm, width 43 mm, depth 8 mm.  
It makes it possible to install wallplate elbows and tees with a bolt or nut on a wall or in wall grooves.  
Do not use in drywall.



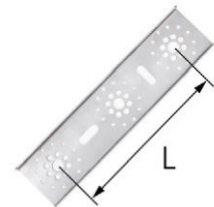
### Double metal mounting plate

GROUP: A

Spacing (L) [mm]	*	Code			UM
80, 150		1700210014	1	42	pc.

**Note:**

Plate total length 210 mm, width 55 mm, depth 9 mm.  
It allows wall elbows and wall tees with a nut or mounting bolt to be installed on the wall, in wall grooves and drywall.  
Screws for mounting tap connections included (6 pcs.).



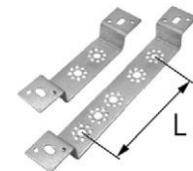
### Double metal bent mounting plate

GROUP: A

Spacing (L) [mm]	*	Code			UM
50, 80, 150		1700210002	10	20	pc.
50		1700210013	10	80	pc.


**Note:**

Plate 50, 80, 150 mm - total length 290 mm, width 40 mm, depth 28 mm.  
Plate 50 mm - total length 190 mm, width 40 mm, depth 28 mm.  
It makes it possible to install wallplate elbows and tees with a bolt or nut on a wall, in wall grooves and drywall.



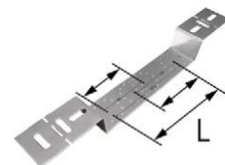
### Metal bent mounting plate for dry screed wallplate elbows

GROUP: A

Spacing (L) [mm]	*	Code			UM
80, 100, 150		1700210025	1	30	pc.

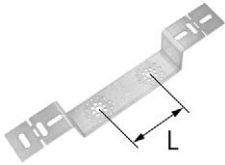
**Note:**

Plate total length 436 mm, width 60 mm, bend 42 mm.  
It allows wall elbows and wall tees to be installed with a bracket on the wall, in wall grooves and drywall.  
The plate is sold with a set of screws (6 pcs.) for fixing elbows and wall tees.



 coil  bar  pipes in tube  bag  carton box  pallet  new  available soon

\* custom-made - lead time max 4 weeks | \*\* availability as agreed | \*\*\* while stock lasts



## Bent mounting plate

**GROUP: A**

Spacing (L) [mm]	*	Code			UM
<b>N</b> 100		<b>1700210027</b>	1	30	pc.

Plate total length 383 mm, width 60 mm, bend 42 mm.  
The plate is sold with a set of screws (6 pcs.) for fixing elbows and wall tees.

 coil 
  bar 
  pipes in tube 
  bag 
  carton box 
  pallet 
 **N** new 
  available soon


\* custom-made - lead time max 4 weeks | \*\* availability as agreed | \*\*\* while stock lasts



## Tools

### Pipe cutter for PERTAL pipes


GROUP: K

Range [mm]	*	Code		UM
14-32		1936267054	1	pc.



### Pipe cutter blade for PERTAL pipe


GROUP: K

Range [mm]	*	Code		UM
14-32		1936267059	1	pc.



### Roller cutter for PERTAL pipes


GROUP: K

Range [mm]	*	Code		UM
16-63		1936267056	1	pc.



### Cutting wheel for PERTAL pipes


GROUP: K

Range [mm]	*	Code		UM
16-63		1941267039	1	pc.



### Calibrator for PERTAL pipes

GROUP: K

Size [mm]	*	Code		UM
16		1936267026	1	pc.
20		1936267028	1	pc.
25 / 26		1936267030	1	pc.



 coil 
  bar 
  pipes in tube 
  bag 
  carton box 
  pallet 
  new 
  available soon

\* custom-made - lead time max 4 weeks | \*\* availability as agreed | \*\*\* while stock lasts



### Universal calibrator for PERTAL pipes

GROUP: K

Size [mm]	*	Code		UM
16 / 20 / 25 / 26		1936267044	1	pc.
25 / 26 / 32 / 40		1936267039	1	pc.
50 / 63	*	1936267046	1	pc.



### Tool set - KAN-therm Mini battery press tool + "U" profile jaws

GROUP: K

Range [mm]	*	Code		UM
<b>N</b> 16-32		1936055010	1	pc.

Each set includes:

- 1936055008 - KAN-therm Mini battery press tool - 1 pc.,
- 1936267273 - jaws U16 - 1 pc.,
- 1936267274 - jaws U20 - 1 pc.,
- 1936267275 - jaws U25 - 1 pc.,
- 1936267277 - jaws U32 - 1 pc.,
- 1967267051 - battery RAML1225 Li-Ion 10,8V 2,5Ah - 2 pcs.,
- 1967267024 - charger LGML1 ~230V 35W - 1 pc.,
- case - 1 pc.



### KAN-therm AC 3000 electric press tool

GROUP: K

Range [mm]	*	Code		UM
<b>N</b> 16-54		1936267239	1	pc.

**Note:**

The press tool is sold in a case.



### KAN-therm DC 4000 battery press tool

GROUP: K

Range [mm]	*	Code		UM
<b>N</b> 16-40		1936267238	1	pc.

**Note:**

The press tool is sold with a battery, charger and case.



### Charger for KAN-therm DC 4000 battery press tool

GROUP: K

Version	*	Code		UM
<b>N</b> 10,8-36 V		1936267267	1	pc.



### Battery for KAN-therm DC 4000 press tool

GROUP: K

Version	*	Code		UM
<b>N</b> 18 V / 4 Ah		1936267266	1	pc.

### KAN-therm "U" profile press jaws

GROUP: K


Size [mm]	*	Code		UM
N 16		1936267257	1	pc.
N 20		1936267258	1	pc.
N 25		1936267259	1	pc.
N 32		1936267260	1	pc.
N 40		1936267261	1	pc.

**Note:**  
The jaws work with KAN-therm: AC 3000, DC 4000 drives.



### KAN-therm "TH" profile press jaws

GROUP: K

Size [mm]	*	Code		UM
N 16		1936267241	1	pc.
N 20		1936267242	1	pc.
N 25		1936267271	1	pc.
N 26		1936267243	1	pc.
N 32		1936267244	1	pc.
N 40		1936267272	1	pc.

**Note:**  
The jaws work with KAN-therm: AC 3000, DC 4000 drives.



### KAN-therm "C" profile press jaws

GROUP: K

Size [mm]	*	Code		UM
N 26		1936267245	1	pc.

**Note:**  
The jaws work with KAN-therm: AC 3000, DC 4000 drives.



### REMS Eco-Press press tool

GROUP: K

Range [mm]	*	Code		UM
16-26		1936267174	1	pc.

**Note:**  
Manual press tool is intended for making pipe connections of Ø16, Ø20, Ø25, Ø26 mm in diameter.





### REMS "U" profile press jaws

GROUP: K

Size [mm]	*	Code		UM
14	*	1936267220	1	pc.
16		1936267122	1	pc.
20		1936267125	1	pc.
25		1936267127	1	pc.
26		1936267130	1	pc.
32		1936267137	1	pc.
40		1936267139	1	pc.

**Note:**

The jaws work with Power-Press SE, Akku-Press, Power-Press ACC, Eco-Press (14-26 mm) drives.



### REMS "TH" profile press jaws

GROUP: K

Size [mm]	*	Code		UM
14	*	1948267107	1	pc.
16	*	1948267109	1	pc.
20	*	1948267114	1	pc.
25	*	1948267116	1	pc.
26	*	1936267101	1	pc.
32	*	1936267103	1	pc.
40	*	1936267105	1	pc.

**Note:**

The jaws work with Power-Press SE, Akku-Press, Power-Press ACC, Eco-Press (14-26 mm) drives.



### REMS "TH" profile press jaws

GROUP: K

Size [mm]	*	Code		UM
50	*	1936267134	1	pc.
63	*	1936267136	1	pc.

**Note:**

The jaws work with Power-Press SE, Akku-Press, Power-Press ACC drives.



### Case for Eco-Press tool

GROUP: K

	*	Code		UM
	*	1941267135	1	pc.

coil bar pipes in tube bag carton box pallet **N** new available soon

\* custom-made - lead time max 4 weeks | \*\* availability as agreed | \*\*\* while stock lasts

## Tool set

GROUP: K

Range [mm]	*	Code		UM
16-26		1936267217	1	set

**Note:**

The press tool is sold with a case.

Each set includes:

- 1936267174 - manual press tool, separated, for Press connectors with a pressed sleeve,
- 1936267122 - jaws U16 for a press tool,
- 1936267125 - jaws U20 for a press tool,
- 1936267130 - jaws U26 for a press tool,
- 1936267054 - pipe cutter for PERTAL pipes,
- 1936267044 - calibrator for PERTAL pipes Ø16/Ø20/Ø25-26,
- 1941267135 - case for the manual separated press tool.



## Tool set

GROUP: K

Range [mm]	*	Code		UM
16-25		1938267158	1	set

**Note:**

The press tool is sold with a case.

Each set includes:

- 1936267174 - manual press tool, separated, for Press connectors with a pressed sleeve,
- 1936267122 - jaws U16 for a press tool,
- 1936267125 - jaws U20 for a press tool,
- 1936267127 - jaws U25 for a press tool,
- 1936267054 - pipe cutter for PERTAL pipes,
- 1936267044 - calibrator for PERTAL pipes Ø16/Ø20/Ø25-26,
- 1941267135 - case for the manual separated press tool.



## Tool set LIGHT

GROUP: K

Range [mm]	*	Code		UM
16-20		1936267218	1	pc.

**Note:**

The press tool is sold with a case (1941267135).

Each set includes:


- 1936267174 - manual press tool, separated, for Press connectors with a pressed sleeve,
- 1936267122 - jaws U16 for a press tool,
- 1936267125 - jaws U20 for a press tool,
- 1936267026 - calibrator for PERTAL pipes Ø16,
- 1936267028 - calibrator for PERTAL pipes Ø20,

The set covers diameters 16-20 mm.



## Case for additional Press tools


GROUP: K

	*	Code		UM
		1941267129	1	pc.



## Set of additional Press tools

GROUP: K

Range [mm]	*	Code		UM
16-63		1936267216	1	set

Each set includes:

- 1936267044 - calibrator for PERTAL pipes Ø16, Ø20, Ø25-26 - 1 pc.
- 1936267039 - calibrator for PERTAL pipes Ø25-26, Ø32, Ø40 - 1 pc.
- 1936267046 - calibrator for PERTAL pipes Ø50, Ø63 - 1 pc.
- 1936267056 - cutter for PERTAL pipes Ø16-63 - 1 pc.
- 1936267054 - shears for PERTAL pipes Ø16-32 - 1 pc.
- 1941267129 - case - 1 pc.





### Set of REMS "TH" profile press jaws

GROUP: K

Range [mm]	*	Code		UM
50-63		1936267215	1	set

Each set includes:

- 1936267134 - jaws TH50 for press tool - 1 pc.
- 1936267136 - jaws TH63 for press tool - 1 pc.
- case - 1 pc.

The jaws work with Power-Press SE, Akku-Press, Power-Press ACC drives.



### REMS Power-Press SE "U" profile press tool set

GROUP: K

Range [mm]	*	Code		UM
16-40		1936267167	1	set

Each set includes:

- 1936267160 - electric press tool - 1 pc.
- 1936267122 - jaws U16 for press tool - 1 pc.
- 1936267125 - jaws U20 for press tool - 1 pc.
- 1936267127 - jaws U25 for press tool - 1 pc.
- 1936267137 - jaws U32 for press tool - 1 pc.
- 1936267139 - jaws U40 for press tool - 1 pc.
- case - 1 pc.



### REMS Power-Press ACC electric press tool

GROUP: K

Range [mm]	*	Code		UM
16-63		1936267219	1	pc.

**Note:**

The press tool is sold with a case.  
The set does not include jaws.



### REMS Power-Press SE Basic Pack electric press tool

GROUP: K

Range [mm]	*	Code		UM
16-63		1936267160	1	pc.

**Note:**

The press tool is sold with a case.  
The set does not include jaws.



### REMS Akku Press battery press tool

GROUP: K

Range [mm]	*	Code		UM
16-63		1936267152	1	pc.

**Note:**

The press tool is sold with a battery, charger and case.  
The set does not include jaws.



### Tool set - Novopress ACO103 BT press tool + "U" profile jaws

GROUP: K

Range [mm]	*	Code		UM
16-32		1936055004	1	pc.

Each set includes:

- battery press tool ACO103 - 1 pc.
- 1936267113 - jaws U16 for press tool - 1 pc.
- 1936267114 - jaws U20 for press tool - 1 pc.
- 1936267115 - jaws U25 for press tool - 1 pc.
- 1936267116 - jaws U32 for press tool - 1 pc.
- 1938267047 - charger - 1 pc.
- 1938267002 - battery 2 Ah - 2 pcs.
- case

## Tool set - Novopress ACO103 BT press tool + "TH" profile jaws GROUP: K

Range [mm]	*	Code		UM
16-32	*	1936055005	1	pc.

Each set includes:

- battery press tool ACO103 - 1 pc.
- 1936267108 - jaws TH16 for press tool - 1 pc.
- 1936267109 - jaws TH20 for press tool - 1 pc.
- 1936121003 - jaws TH25 for press tool - 1 pc.
- 1936267111 - jaws TH32 for press tool - 1 pc.
- 1938267047 - charger - 1 pc.
- 1938267002 - battery 2 Ah - 2 pcs.
- case



## Novopress EFP203 electric press tool GROUP: K

Range [mm]	*	Code		UM
16-63		1948267210	1	pc.

**Note:**

The press tool is sold with a plastic case.



## Novopress ACO203XL BT press tool GROUP: K


Range [mm]	*	Code		UM
16-63		1948267181	1	pc.

Each set includes:

- Battery press tool - 1 pc.
- Battery 18 V/ 5.0 Ah Li-Ion Milwaukee - 2 pcs.
- Charger - 1 pc.
- Lubricant - 1 pc.
- Plastic case



## Novopress PB2 "U" profile press jaws GROUP: K

Size [mm]	*	Code		UM
14	*	1936267231	1	pc.
16		1936267232	1	pc.
20		1936267233	1	pc.
25		1936267234	1	pc.
32		1936267235	1	pc.
40		1936267236	1	pc.

**Note:**

The jaws work with EFP203 and ACO203XL drives.





### Novopress PB2 "TH" profile press jaws

GROUP: K

Size [mm]	*	Code		UM
14	*	1936267222	1	pc.
16		1936267223	1	pc.
20		1936267224	1	pc.
25		1936267225	1	pc.
26		1936267226	1	pc.
32		1936267227	1	pc.
40		1936267228	1	pc.

**Note:**  
The jaws work with EFP203 and ACO203XL drives.



### Novopress "TH" profile collar

GROUP: K

Size [mm]	*	Code		UM
50		1936267229	1	pc.
63		1936267230	1	pc.

**Note:**  
The jaws work with EFP203 and ACO203XL drives.  
Use with ZB203 adapter.



### Novopress ZB203 adapter

GROUP: K

Range [mm]	*	Code		UM
50-63		1948267000	1	pc.

**Note:**  
Adapter for EFP203 and ACO203XL drives.  
Press: 50-63 mm  
Steel & Inox: 35-54 mm  
Copper: 42-54 mm



### External spring for bending pipes

GROUP: K

Size [mm]	*	Code			UM
16		1936267081	1	60	pc.
20		1936267086	1	40	pc.
25-26		1936267088	1	25	pc.

**Note:**  
The external spring works with PERTAL<sup>2</sup> and PERTAL pipes.



### Internal spring for pipes bending

GROUP: K

Size [mm]	*	Code			UM
16		1936267075	1	10	pc.
20		1936267077	1	10	pc.
25-26		1936267071	1	10	pc.

**Note:**  
The internal spring works with PERTAL pipes.

coil bar pipes in tube bag carton box pallet **N** new available soon

\* custom-made - lead time max 4 weeks | \*\* availability as agreed | \*\*\* while stock lasts



## Combination wrench for G<sup>3/4</sup>" eurocone adapters

GROUP: K

Size [mm]	*	Code			UM
30	*	1938267035	1	15	pc.

**Note:**

The wrench is intended for assembling G<sup>3/4</sup>" Eurocone adapters.



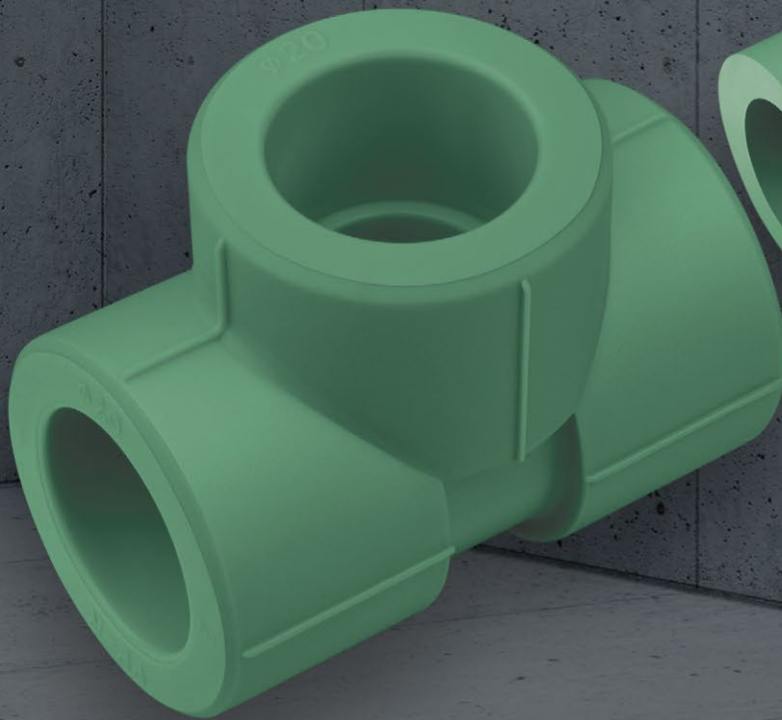
 coil  bar  pipes in tube  bag  carton box  pallet **N** new  available soon

\* custom-made - lead time max 4 weeks | \*\* availability as agreed | \*\*\* while stock lasts





Install your **future**



SYSTEM **KAN-therm**

**PP Green**

High quality with  
reasonable price

EN 24/07

Ø 20-200 mm

## 2 SYSTEM **KAN-therm** PP Green

<b>2.1</b>	<b>General information</b> .....	<b>61</b>
<b>2.2</b>	<b>KAN-therm PP Green pipes</b> .....	<b>62</b>
	Physical properties of KAN-therm PP Green pipe material .....	64
	Pipe marking, color .....	64
	Dimension parameters of KAN-therm PP Green pipes .....	65
<b>2.3</b>	<b>Fittings and other elements of the system</b> .....	<b>67</b>
<b>2.4</b>	<b>Scope of use</b> .....	<b>67</b>
<b>2.5</b>	<b>Technique of connecting KAN-therm PP Green installations – welded joints</b> .....	<b>70</b>
	Tools – preparation of the welder .....	71
	Preparation of elements for welding .....	72
<b>2.6</b>	<b>Welding technique</b> .....	<b>73</b>
	Socket fusion welding .....	73
	Installation of pipe saddle fittings PP Green .....	74
	Connection technique - electrofusion welding (20-200 mm) .....	75
	Connections technique - butt-welding (90 – 200 mm) .....	76
<b>2.7</b>	<b>Fittings with metal threads and collars</b> .....	<b>77</b>
<b>2.8</b>	<b>Transport, storage and handling</b> .....	<b>79</b>
<b>2.9</b>	<b>Safety</b> .....	<b>79</b>

### System **KAN-therm** PP Green - assortment

Pipes .....	81
Connectors .....	83
Accessories .....	94
Tools .....	95

## 2 SYSTEM KAN-therm PP Green

### 2.1 General information

KAN-therm PP Green is a complete installation system consisting of pipes and fittings made of polypropylene PP-R (type 3) or PP-RCT (type 4), a thermoplastic material, with diameter range: 20–200 mm. Connecting elements is performed using the welding technique (thermal polyfusion) and electric welders. This welding technique creates continually uniform joints and therefore guarantees exceptional tightness and mechanical durability of the installation. The system is designed for indoor water supply installations (hot and cold potable water), heating and technological installations.

The KAN-therm PP Green system is characterized by:

- high hygiene of all products (physiological and microbiological neutrality),
- high chemical resistance,
- resistance to material corrosion,
- low thermal conductivity (high thermal insulation of pipes),
- low specific weight,
- resistance to scaling,
- muffling vibrations and noises,
- mechanical durability,
- uniform joints,
- high usage durability.

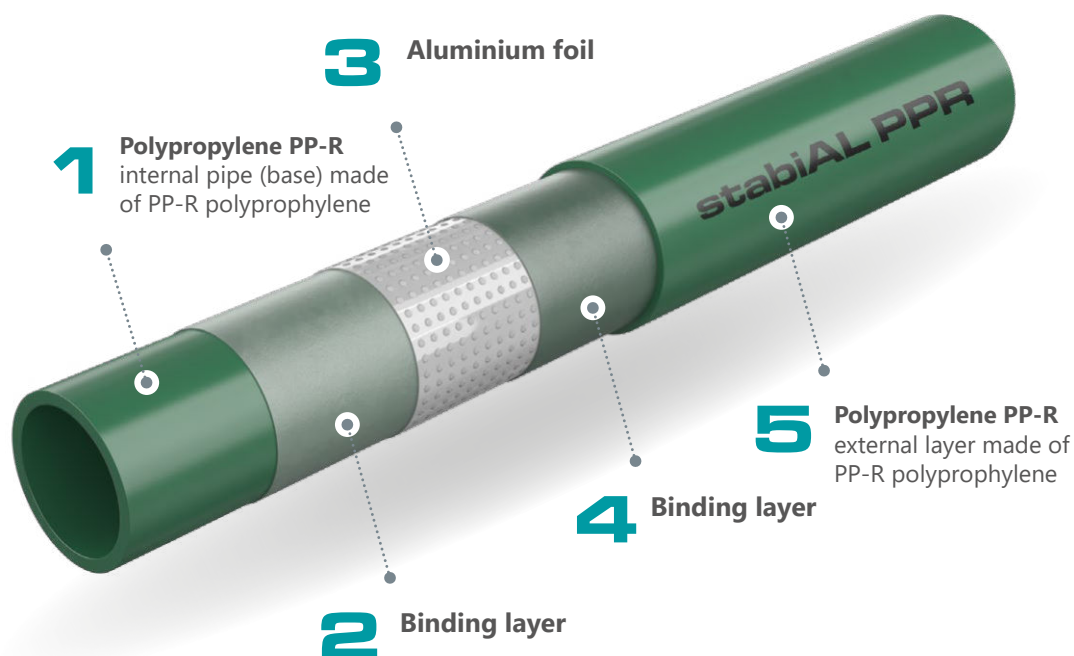
## 2.2 KAN-therm PP Green pipes

KAN-therm PP Green pipes and fittings are manufactured of high quality PP-R polypropylene (random copolymer of polypropylene), formerly marked as polypropylene type 3. The offer also includes pipes and fittings made of the latest generation material - PP-RCT (Random Crystallinity Temperature Polypropylene).

In terms of structure, we differentiate following types of pipes: uniform (homogenous PPR) and compound pipes: stabilized with a layer of aluminum, the so-called stabiAL PPR pipes or multilayer pipes reinforced with a layer of glass fiber, the so-called stabiGLASS PPR or PPRCT pipes.

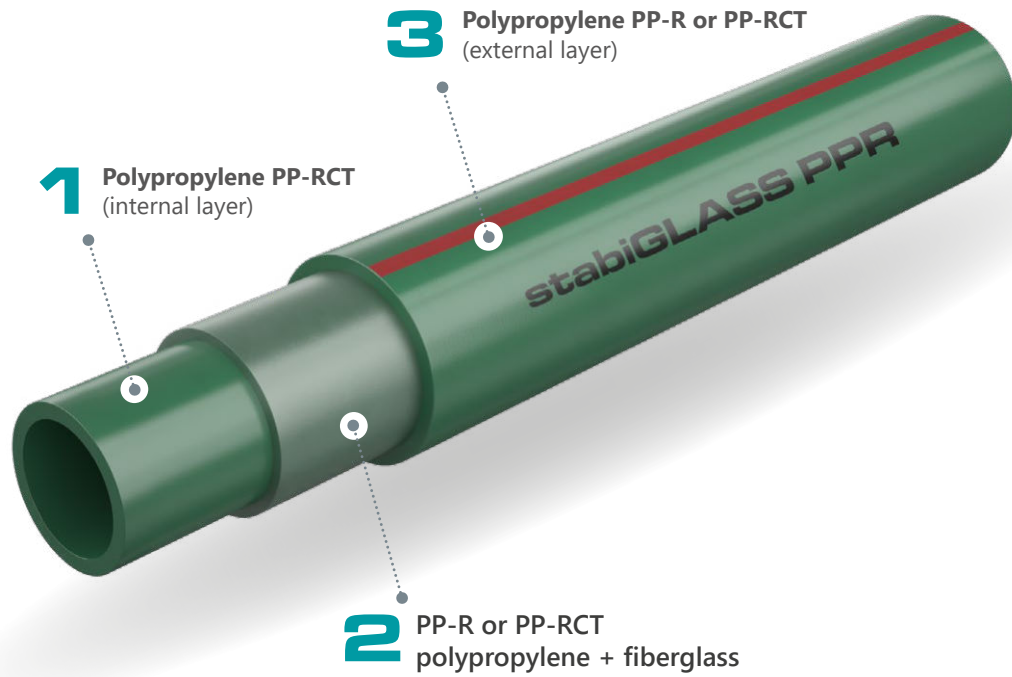
KAN-therm PP Green stabiAL PPR pipes consist of a PP-R base pipe made of polypropylene, which is coated with a layer of perforated aluminum tape, 0,13 mm thick, overlapping and additionally covered with a protective layer of polypropylene. For increased durability of the aluminum-polypropylene joint, double adhesive binding layers are applied.

The basic function of the aluminum insert in stabiAL PPR compound pipes is to significantly reduce the thermal elongations of pipes ( $\alpha = 0,03 \text{ mm/m} \times \text{K}$ ; for uniform pipes  $\alpha = 0,15 \text{ mm/m} \times \text{K}$ ). The aluminum layer also serves as additional partial protection against the diffusion of oxygen from the environment.



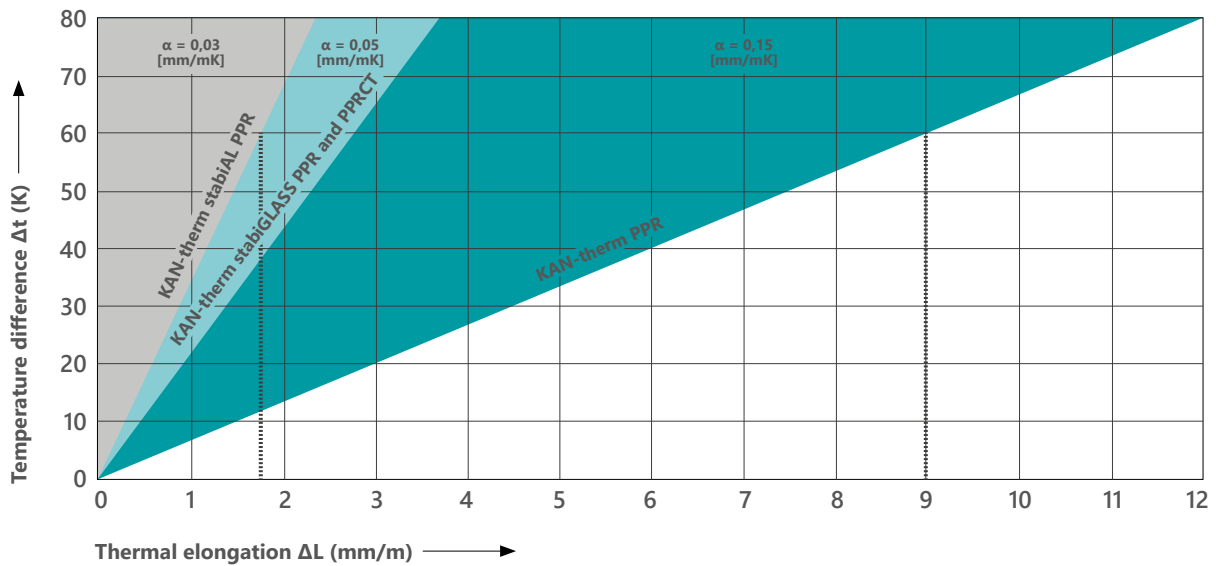
Structure of a stabiAL PPR compound pipe

KAN-therm PP Green stabiGLASS PPR or PPRCT pipes also feature multilayer structure. Their internal layer, which is reinforced with glass fibre (40% of pipe wall thickness) determines very high durability of the pipe and its low thermal elongation  $\alpha=(0,05 \text{ mm/m} \times \text{K})$ .



Structure of a stabiGLASS PPR and PPRCT\*

\*stabiGLASS PPRCT pipes (125-200 mm) are not marked with a red strip.



Comparison of the thermal expansion factor in uniform PPR and both stabiAL PPR and stabiGLASS PPR or PPRCT pipes.

## Physical properties of KAN-therm PP Green pipe material

Property	Symbol	Unit	Value	
			PPR	PPRCT
linear elongation coefficient	$\alpha$	mm/m × K	0,15 for uniform pipes	0,05 for stabiGLASS PPRCT
			0,03 for stabiAL PPR pipes	
			0,05 for stabiGLASS PPR pipes	
thermal conductivity	$\lambda$	W/m × K	0,24	
density	$\rho$	g/cm <sup>3</sup>	0,90	
elasticity module		N/mm <sup>2</sup>	900	850
minimum bend radius	$R_{min}$	mm	8 × De	
internal wall roughness	k	mm	0,007	

## Pipe marking, color

KAN-therm PP Green pipes are marked in a continuous manner with inscriptions with a 1-meter span, containing i. e. the following indications:

Marking description	Example of marking
Name of manufacturer and/or trademark:	KAN, KAN-therm
Nominal external diameter x wall thickness	16 × 2,7
Dimension class	A
Pipe structure (material)	PP-R
Pipe code	04000316
Number of Standard or Technical Certificate	EN 15874
Pressure/dimension ratio	PN20 SDR6
Application class/es with design pressure	Class 1/10 bar – 2/8 bar – 4/10 bar – 5/6 bar
Date of production	18.08.09
Other manufacturer markings, e.g. running meter, batch number	045 m



**Notice – other, additional markings, e.g. numbers of certificates may also be inscribed on the pipe.**

**Pipe color:** green;

**Pipe surface:** mat (uniform and stabiGLASS PPRCT) or coarse (stabiAL PPR pipes). stabiGLASS PPR pipes are green with a red stripe.

Pipes are supplied 4 m long bars.



## Dimension parameters of KAN-therm PP Green pipes

KAN-therm PP Green system offers five types of pipes, differing in terms of wall thickness and structures (compound pipes):

PPR PN16 pipes	(20 –110 mm)
PPR PN20 pipes	(20 –110 mm)
stabiAL PPR PN20 pipes	(20 –110 mm)
stabiGLASS PPR PN16 pipes	(20 –110 mm)
stabiGLASS PPRCT PN16 pipes	(125 –200 mm)



Tab. 1. KAN-therm PP Green PPR PN16 pipes (S3,2/SDR7,4)

Size [mm]	External diameter D [mm]	Wall thickness s [mm]	Internal diameter d [mm]	Capacity by unit [l/m]	Weight by unit [kg/m]
20 x 2,8	20	2,8	14,4	0,163	0,148
25 x 3,5	25	3,5	18,0	0,254	0,230
32 x 4,4	32	4,4	23,2	0,415	0,370
40 x 5,5	40	5,5	29,0	0,615	0,575
50 x 6,9	50	6,9	36,2	1,029	0,896
63 x 8,6	63	8,6	45,8	1,633	1,410
75 x 10,3	75	10,3	54,4	2,307	2,010
90 x 12,3	90	12,3	65,4	3,358	2,870
110 x 15,1	110	15,1	79,8	4,999	4,300

Tab. 2. KAN-therm PP Green PPR PN20 pipes (S2,5/SDR6)

Size [mm]	External diameter D [mm]	Wall thickness s [mm]	Internal diameter d [mm]	Capacity by unit [l/m]	Weight by unit [kg/m]
16 x 2,7	16	2,7	10,6	0,088	0,110
20 x 3,4	20	3,4	13,2	0,137	0,172
25 x 4,2	25	4,2	16,6	0,216	0,266
32 x 5,4	32	5,4	21,2	0,353	0,434
40 x 6,7	40	6,7	26,6	0,556	0,671
50 x 8,3	50	8,3	33,4	0,866	1,050
63 x 10,5	63	10,5	42,0	1,385	1,650
75 x 12,5	75	12,5	50,0	1,963	2,340
90 x 15,0	90	15,0	60,0	2,827	3,360
110 x 18,3	110	18,3	73,4	4,208	5,040

**Tab. 3. KAN-therm PP Green stabiAL PPR PN20 pipes (S2,5/SDR6)**

Size [mm]	External diameter D [mm]	Wall thickness s [mm]	Internal diameter d [mm]	Capacity by unit [l/m]	Weight by unit [kg/m]
16 × 2,7	16 (17,8)*	2,7	10,6	0,088	0,160
20 × 3,4	20 (21,8)*	3,4	13,2	0,137	0,218
25 × 4,2	25 (26,9)*	4,2	16,6	0,216	0,328
32 × 5,4	32 (33,9)*	5,4	21,2	0,353	0,520
40 × 6,7	40 (41,9)*	6,7	26,6	0,556	0,770
50 × 8,3	50 (51,9)*	8,3	33,4	0,866	1,159
63 × 10,5	63 (64,9)*	10,5	42,0	1,385	1,770
75 × 12,5	75 (76,9)*	12,5	50,0	1,963	2,780
90 × 15,0	90 (92)*	15,0	60,0	2,830	3,590
110 × 18,3	110 (112)*	18,3	73,4	4,210	5,340

\* in brackets: average external diameter of the pipe with Al foil and protective shield

External dimensions of compound pipes with aluminum foil differ from the dimensions of uniform pipes (external diameter is slightly bigger due to the thickness of Al foil and the thickness of the PP-R protective shield). The nominal size of these pipes corresponds to the external diameters of base pipes.

**Tab. 4. KAN-therm PP Green stabiGLASS PPR PN16 pipes (S3,2/SDR7,4)**

Size [mm]	External diameter D [mm]	Wall thickness s [mm]	Internal diameter d [mm]	Capacity by unit [l/m]	Weight by unit [kg/m]
20 × 2,8	20	2,8	14,4	0,163	0,160
25 × 3,5	25	3,5	18,0	0,254	0,250
32 × 4,4	32	4,4	23,2	0,415	0,430
40 × 5,5	40	5,5	29,0	0,615	0,650
50 × 6,9	50	6,9	36,2	1,029	1,000
63 × 8,6	63	8,6	45,8	1,633	1,520
75 × 10,3	75	10,3	54,4	2,307	2,200
90 × 12,3	90	12,3	65,4	3,358	3,110
110 × 15,1	110	15,1	79,8	4,999	4,610

**Tab. 5. KAN-therm stabiGLASS PPRCT PN16 (S4/SDR9)**

DN	External diameter D [mm]	Wall thickness s [mm]	Internal diameter d [mm]	Capacity by unit [l/m]	Weight by unit [kg/m]
125 × 14,0	140	14	97	12,27	4,48

**Tab. 6. KAN-therm stabiGLASS PPRCT PN16 (S5/SDR11)**

DN	External diameter D [mm]	Wall thickness s [mm]	Internal diameter d [mm]	Capacity by unit [l/m]	Weight by unit [kg/m]
160 × 14,6	160	14,6	130,8	20,1	6,78
200 × 18,2	200	18,2	163,6	31,4	10,64

## Explanation of markings of uniform PPR pipes

S	dimension series according to ISO 4	$S = (D-s)/2s$
SDR	Standard Dimension Ratio	$SDR = 2 \times S + 1 = D/s$
D(dn)	nominal external pipe diameter	
s(en)	nominal wall thickness	in brackets: markings acc. to standard
PN	Pressure nominal	

S	SDR	PN
5	11	10
3,2	7,4	16
2,5	6	20

## 2.3 Fittings and other elements of the system

The basic method of executing joints in polypropylene installations is thermal welding which, thanks to the use of proper fittings, allows connecting pipes (pipe couplings), closing the pipeline (end caps), redirecting the pipeline (elbows, bends, passing loops, tees), changing the diameter of the pipe (couplings and reducers), executing branch-offs (tees, four-ways), connecting devices and fixtures (collar joints and metal threaded joints). Ball valves with polypropylene couplings serve as the joints here.

All of the above mentioned elements allow connecting fittings to pipes or connecting two or more pipe sections, forming inseparable joints, requiring the pipe to be cut off if there is a need for disassembling the fitting. In order to execute a separated joint, sleeves for collar joints and union adapters must be used. All joints are universal and may be used with all types of KAN-therm PP Green pipes, irrespective of their wall thickness or structure.

All of the KAN-therm PP Green system fittings are designed in PN20 pressure rating.

KAN-therm PP Green system, apart from pipes, consists of the following elements:

- fittings (uniform) made of PP-R (20-110 mm) or PP-RCT (125-200 mm) polypropylene (couplings, reducers, elbows, nipple elbows, tees),
- couplings with female and male metal threads ½" – 3" – used for connecting to devices and fixtures,
- sleeves for collar joints with loose collars, union adapters – for detachable joints,
- expansion bends, mounting plates, ball valves,
- mounting elements – plastic or metal with rubber insert clamps,
- tools for pipe bending, treatment and welding.

## 2.4 Scope of use

Thanks to the properties of PP-R and PP-RCT material, the KAN-therm PP Green installation system has a wide spectrum of applications:

- cold (20 °C/1,0 MPa) and hot (60 °C/1,0 MPa) water installations in housing buildings, hospitals, hotels, office buildings, schools,
- central heating installations (temp. up to 90 °C, working pressure up to 0,6 MPa),
- compressed air installations,
- balneology installations,
- installations in agriculture and horticulture,
- pipelines in the industry, e.g. for transporting aggressive media and food products,
- ship installations.

The scope of use assumes new installations, as well as repairs, modernization and exchange projects.

Thanks to special properties of polypropylene (physiological and microbiological neutrality, resistance to corrosion, resistance to scaling, immunity to vibrations, very good thermal insulation of pipes), KAN-therm PP Green system installations are widely used, particularly in water supply installations, when mounting water supply risers and installation levels. This refers to both hot and cold tap water installations in housing buildings, hospitals, hotels, office buildings, schools, on ships, etc.



KAN-therm PP Green installation

KAN-therm PP Green installations are perfect for replacing old, corroded water supply installations. They are also used in renovations of old heating installations.

Pipes and joints in the KAN-therm PP Green system are in full compliance with applicable standards, which guarantees their long-term and reliable operation as well as full security of assembly and use of the installation.

Certificates and technical approvals are available at [www.kan-therm.com](http://www.kan-therm.com).

The operational parameters and scopes of use of KAN-therm PP Green pipe installations in heating and water supply installations are presented in the table.

Application (acc. to ISO 10508)	Total time of exploitation, years	Time of operation years/hours	Operating temperature T °C	PPR		PPRCT	
				SDR6 (S2,5), SDR6 (S2,5) stabiAL	SDR7,4 (S3,2), SDR7,4 (S3,2) stabiGLASS	SDR9 (S4)	SDR11 (S5)
				Maximum operating pressure (bar)			
Hot domestic water [application class 1] $T_d / T_{max} = 60/80$ °C	50	49 1	60 80	10	8	10	8
	Time of operation at $T_{mal}$	100 hours	95				
Hot domestic water [application class 2] $T_d / T_{max} = 70/80$ °C	50	49 1	70 80	8	6	8	6
	Time of operation at $T_{mal}$	100 hours	95				
Radiant heating, low temperature radiator heating [application class 4] $T_d / T_{max} = 60/70$ °C	50	2,5	20	10	10	8	6
		20	40				
		25	60				
		2,5	70				
Time of operation at $T_{mal}$	100 hours	100					
Radiator heating [application class 5] $T_d / T_{max} = 80/90$ °C	50	14	20	6	6	6	4
		25	60				
		10	80				
		1	90				
Time of operation at $T_{mal}$	100 hours	100					

Tab. 7. Maximum operating pressure of PPR and PPRCT pipes depending on the temperature and service life of the installation (safety factor C=1,25)

Temperature [°C]	Time [years]	PP-R pipes		PP-RCT pipes	
		SDR7,4 / S3,2	SDR6 / S2,5	SDR11 / S5	SDR9 / S4
10	1	33,1	42,5	23	28,8
	5	31,2	40	22,3	28
	10	30,5	39	22	27,6
	25	29,4	37,7	21,6	27,1
	50	28,7	36,7	21,4	26,8
20	1	28,3	36,2	20	25,1
	5	26,6	34,1	19,3	24,4
	10	25,9	33,1	19,1	24
	25	25	32	18,7	23,5
	50	24,4	31,2	18,5	23,2
40	1	20,4	26,2	14,9	18,7
	5	19,1	24,5	14,4	18
	10	18,6	23,8	14,2	17,8
	25	17,9	22,8	13,8	17,4
	50	17,4	22,2	13,7	17,2
60	1	14,6	18,7	10,8	13,6
	5	13,6	17,4	10,3	13
	10	13,2	16,8	10,2	12,7
	25	12,6	16,1	10	12,5
	50	12,2	15,6	9,7	12,2
70	1	12,2	15,7	9	11,4
	5	11,4	14,5	8,6	10,9
	10	11	14	8,5	10,7
	25	9,6	12,2	8,3	10,4
	50	8	10,3	8,2	10,2
80	1	10,3	13,2	7,6	9,5
	5	9,1	11,6	7,2	9
	10	7,7	9,8	7,1	8,9
	25	6,1	7,9	6,8	8,6
	50	5,2	6,7	6,7	8,5
90	1	8,6	11	6,2	7,8
	5	6	7,7	5,9	7,4
	10	5	6,5	5,8	7,3
	25	4,1	5,2	5,6	7,1
95	1	7,3	9,4	5,6	7,1
	5	4,9	6,4	5,4	6,7
	10	4,2	5,3	5,3	6,6



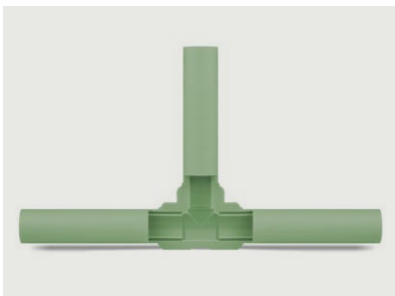
**Note**

Conditions of using the KAN-therm PP Green system in installations other than heating and water supply installations - chemical resistance.

Elements of the KAN-therm PP Green system are characterized by high chemical resistance. You should remember, however, that the chemical resistance feature of polypropylene depends on the type and concentration of substances, as well as other factors, e.g. temperature and pressure of the medium, and ambient temperature. Chemical resistance of the couplings inserts (metal) must not be compared to the resistance of PP-R or PP-RCT elements. Due to this fact, transition couplings are not applicable for all industrial usages. Before deciding on the application of KAN-therm PP Green pipes and joints in installations conducting substances different than water, please contact the KAN's Technical Department.

## 2.5 Technique of connecting KAN-therm PP Green installations – welded joints

Welding is the basic technology used for connecting KAN-therm PP Green polypropylene pipelines. The welding process is based on plasticizing the elements to be connected under high temperature (to a certain depth), and then joining, under right pressure, the plasticized layers and, finally, cooling the entire area to a temperature of hardening.



Cross-section of a welded joint



KAN-therm PP Green tools

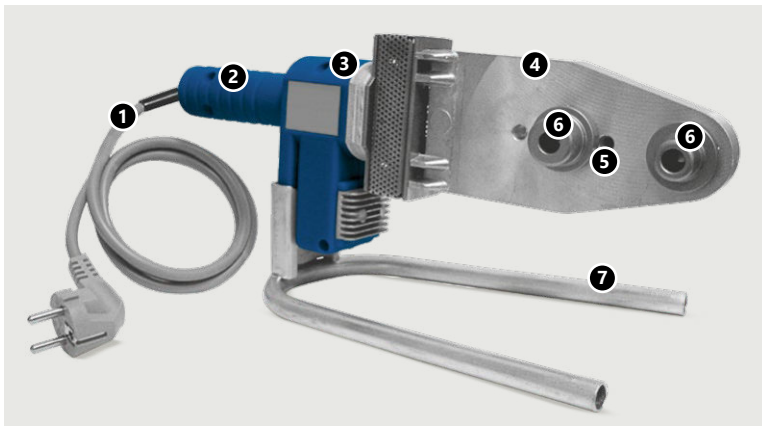
Plasticization of layers to be connected takes place at 260 °C in a temporal function, taking into account the need to warm up a layer of material (external surface of the pipe and internal surface of the coupling) and a required depth. The essence of the process of welding polypropylene, also called thermal polyfusion, is relocating and mixing the polymer chains of plasticized and then pressed layers of elements being connected. Maintaining proper conditions in this process (temperature, time, pressure force and area, cleanness of elements being connected) guarantees proper execution of the joint and its durability.

The process of heating (plasticizing) takes place with the use of an electric welder equipped with a heating plate with exchangeable (for each diameter) heating inserts covered with Teflon.

Depending on the diameter of the pipe, heating takes from 5 to 50 seconds. After this time, heated elements are removed from the inserts and the pipe is immediately mounted (without rotation!) inside the coupling at a depth which must be marked earlier. It is then that the particles of both elements penetrate one another and mix. A joint formed through thermal welding has impressive mechanic durability, exceeding the durability of the pipe itself (the cross section of the joint exceeds the cross section of the pipe).

## Tools – preparation of the welder

In order to execute a polypropylene joint, use a welder designed to work under 230 V. This device consists of a power supply cable (1), a grip (2) with an in-built thermostat and controls (diodes) (3) and a heating plate (4), which heating inserts (6) are mounted to. The power of KAN-therm welders is 800 or 1600 W.



### Welder elements

1. Power supply cable
2. Welder grip
3. Power supply and thermostat controls
4. Heating plate
5. Openings in the heating plate
6. Heating inserts
7. Stand



### Welding temperature 260 °C

- Before starting any works, read the instruction manual to the corresponding welder type.
- Heating inserts (coupling and heating rod) must be screwed tightly using a wrench included in the set. They must contact the surface of the heating plate tightly. The inserts must not extend over the edge of the heating plate.
- Secure the inserts against scratching or polluting. Clean all pollutions with a natural cloth and rubbing alcohol.
- Connection to power supply is signaled by the lamp or diode on the casing lighting up.
- The required welding temperature (on the surface of inserts) is 260 °C. The temperature of the heating plate is higher (280-300 °C). When the device reaches the correct welding temperature, a thermostat control most often (depends on the model of the welder) signals it.
- After finishing all works, disconnect the welder from power supply and leave it to cool down. Do not cool the welder rapidly, e.g. using cold water, since this may lead to the damage of heating circuits.
- Do not use a power supply cable of small cross section or one which is too long. Voltage fluctuations might disturb the proper operation of the device.
- Do not use the power supply cable to transport or hang the welder. When out of work, place it on the stand included in the set.



### NOTICE

Due to varying tolerances of pipes and fittings by other manufacturers, to ensure the execution of a sealed and durable joint, we suggest the use of original tools, particularly heating inserts, as offered within the KAN-therm PP Green system.



### Tools – work safety

**All tools must be used according to their dedication and the manufacturer's instruction manual. During the use of tools, one must observe the terms of regular inspections and all applicable safety regulations. Using tools against their designed use may lead to their damage or to the damage of their accessories. It may also lead to the occurrence of leakages in installation joints.**

## Preparation of elements for welding



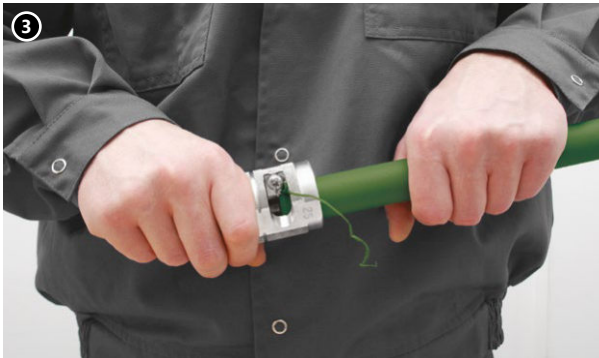
### 1. Cutting the pipe.

Use a pipe cutter, (or for bigger diameters) a round pipe cutter or a mechanic saw with a blade adapted to cutting polypropylene to cut the pipe. When cutting the pipe with a saw, remove all remainings from the surface and from the interior of the pipe.



### 2. Marking the depth of the weld.

Mark (using a ruler or, a template and a pencil) the depth of the weld at the end of the pipe (PPR and stabiGLASS PPR pipes). Insufficient welding depth may weaken the joint. On the other hand, if the pipe is mounted too deep, it may become narrower (flange). The depths of welds are provided in the table.



### 3. Removing Al foil

In the case of stabiAL PPR pipes, before welding, remove the layer of aluminum using a scraper (together with the PP protective shield and binding layers). Slide the end of the Stabi pipe into the hole of the scraper and, applying rotary motion, scrape off the layer of aluminum until the scraper ceases to produce chips. The length of the section with the foil removed signals the depth of the weld, hence there is no need to mark it, as in point 2.

Always check for aluminum or binding layer (adhesive) remains on the surface. Scraper blades must not be blunt or chipped. Replace used blades with new, spare ones.



## 2.6 Welding technique

### General requirements for welding

Only the products coming from the same manufacturer can be welded together. Pipes and fittings should be heated simultaneously and not more than once. All operations during a welding process shall be performed without turning a pipe against a fitting and welding ends. It should be taken into account that welding time differs depending on elements' diameters. Welding below 0 °C should be avoided. Double, even flow-out on the whole weld surface indicates a good quality of a joint. In case of stabAL pipes it is essential to make sure that an aluminum foil has been removed.

### Socket fusion welding



#### 4. Heating the pipe and the joint.

The surfaces to be heated must be clean and dry. Slide the pipe end (without rotation) into the heating sleeve, up to the marked depth of the weld. At the same time, slide the fitting (also without rotation) on the heating rod, until it stops. Start counting the heating time when the pipe and the fitting are mounted at their entire welding depths. After the lapse of a half of the heating time (according to the table), continue to heat the fitting and start heating the pipe, until the end of required heating time.

#### 5. Connecting elements.

After heating take the pipe and fitting out of heating inserts in a continuous manner and immediately, without rotating, connect them. The marked welding border should then be covered by outflowing excess material. Do not heat beyond the marked welding border, since it could result in a narrowing or even a clog in the joint. When connecting elements, the joint can be slightly adjusted on the axis (up to a few degrees). Rotating elements being connected is absolutely prohibited.



#### 6. Stabilizing and cooling.

After the welding time has lapsed, the joint must be stabilized and cooling must be initiated (time of cooling is provided in the table). In this period, you must not apply any mechanic pressure on the pipe. After all joints have cooled down, connect the installation to water supply and conduct a pressure test.

Tab. 8. Socket fusion welding parameters

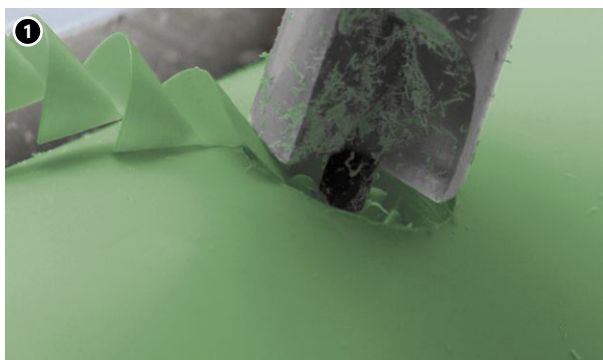
External pipe diameter [mm]	Welding depth [mm]	Heating time [sek]	Binding time [sek]	Cooling time [min]
16	13,0	5	4	2
20	14,0	5	4	2
25	15,0	7	4	2
32	16,0	8	6	4
40	18,0	12	6	4
50	20,0	18	6	4
63	24,0	24	8	6
75	26,0	30	10	8
90	29,0	40	10	8
110	32,5	50	10	8



### Notice

The time of heating in ambient temperatures below +5 °C should be increased by 50%.

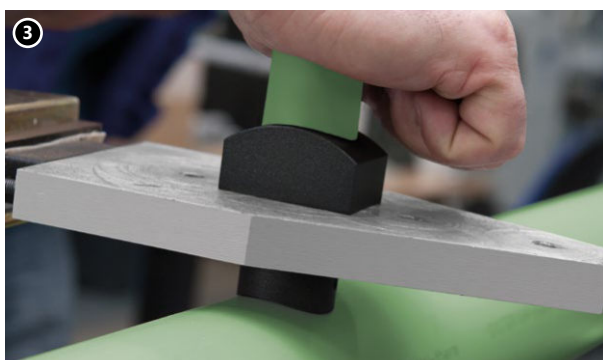
## Installation of pipe saddle fittings PP Green



1. Drilling a hole under the pipe saddle fitting.



2. Processing the hole – removing the burrs made when drilling.



3. Welding the pipe saddle fitting.



4. Ready connection.

## Connection technique - electrofusion welding (20-200 mm)



1. Pipe surface scraping.



2. Cleaning pipe surface with alcohol.



3. Insertion depth marking.



4. Insertion of pipe into the fitting.



5. Programming of welding machine via laser reader (welding machine will adjust parameters automatically).



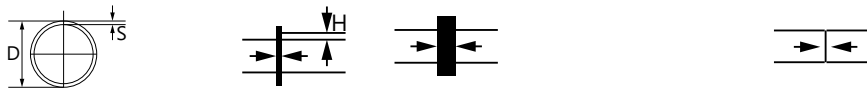
6. Welding process start - do not rotate or mechanically stress the elements through all of welding and cooling process.

Tab. 9. Electrofusion welding parameters

External pipe diameter	R (23 °C)	RMS	Welding time	Cooling time
[mm]	[Ohm]	[Volt]	[sek]	[min]
20	0,76	11	65	10
25	0,76	13	55	10
32	1,25	20	55	10
40	1,9	24	105	10
50	1,41	24	150	15
63	0,85	24	145	15
75	0,79	24	165	20
90	0,76	24	210	20
110	0,57	24	250	20
125	1,16	40	180	20
160	0,84	40	270	30
200	0,56	40	270	30

## Connections technique - butt-welding (90 – 200 mm)

Tab. 10. Butt-welding welding parameters



External pipe diameter	Outflow height	Welding time	Outflow width	Cooling time <15°C	Cooling time 15-25°C	Cooling time 25-40°C
[mm]	[mm]	[s]	[mm]	[min]	[min]	[min]
90	1	138	10±15 mm	10	13	16
110	1	166	10±15 mm	12	15	20
125	1	155	10±15 mm	11	14	18
160	1	161	10±15 mm	12	15	20
200	1	198	10±15 mm	14	18	24

1. Placing the pipe in butt-welding machine.
2. Determining the correct pipe-pipe and pipe-fitting position.
3. Checking the parallelism of the ends by positioning elements together.
4. Milling the welding surfaces – 3 continuous coils of cut material requested.
5. Purging the welding surfaces.
6. Welding – outflows and welding time acc. to table.
7. Cooling down – cooling time acc. to table.

### Thread sealing

It is advised to seal threaded connections with such an amount of hemp, that leaves the thread tops not covered. Using too much hemp may lead to thread damage. By winding hemp just after the first thread ridge you can avoid skew screwing and damaging the thread.



**CAUTION! Do not use chemical sealants or glues.**

## 2.7 Fittings with metal threads and collars

Apart from welded joints, KAN-therm PP Green offers threaded and collar joints.



KAN-therm PP Green fittings with brass threads

The most basic elements with metal threads are PP-R polypropylene fittings (couplings, elbows, tees) with brass "inserts" with male and female threads. They form inseparable joints. Unscrewing a joint like this requires the pipe to be cut off. Such joints are used for connecting installations to heating and water supply devices and fixtures. Joints with 1" and bigger female and male threads are equipped with a six-sided mount for a flat wrench, allowing devices to be screwed-in and – out without applying excessive pressure on the weld and the fitting itself.

The group of detachable joints, allowing performance of multiple, exchangeable connections, includes KAN-therm PP Green union adapters (used e.g. to connect water meters) and "half unions" with specially formed stubs (for mounting rubber seals) and metal nuts.

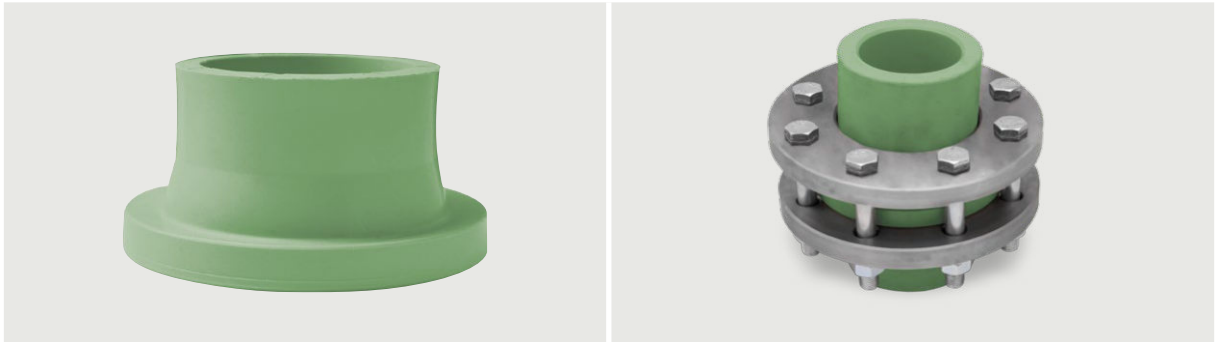


KAN-therm PP Green detachable fittings – male union adapter, female union adapter, half-union and union

KAN-therm PP Green also offers double union adapters (with two PP-R couplings) which allow mounting flanges on the pipe. An additional coupling with internal diameter corresponding to the external diameter of the pipe is required to connect these joints with the pipe.

For large pipe diameters, use flange couplings to execute detachable joints. Flange couplings are used e.g. to connect devices to flange stubs (pumps, valves, water meters). In installations, KAN-therm PP Green adapters are used with loose flanges.

It is necessary to assemble a separate, flat seal. The seal should be made of a material type suitable for the parameters of the medium running through the joint. The connection between flange adapter and pipe is done with a utilization of muff coupling or by other fitting.

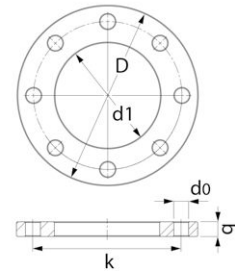


Ø110 mm flange joint

### Flanges

Sleeve size	DN	D	d1	k	d0	q	N
Ø40	32	140	43	100	18	18	4
Ø50	40	150	53	110	18	18	4
Ø63	50	165	66	125	18	20	4
Ø75	65	185	78	145	18	20	8
Ø90	80	200	95	160	18	20	8
Ø110	100	220	114	180	18	22	8

N - number of bolt holes



## 2.8 Transport, storage and handling



Components of plastic piping systems must be protected against impact, falling, blow or any other mechanical damage during their transport and installation.

Store and transport pipes in horizontal position, preventing them from bending.

Maximum storage height – 1,2 m. Be extra careful when transporting or carrying pipes in temperatures below 0 °C (in these conditions pipes are more vulnerable to mechanic damages, especially stabiGLASS PPR pipes).



Protect pipes against shocks or mechanic impacts, particularly their endings.

Do not throw or drag pipes during transport.

Only the components that are not damaged or contaminated, during storage or transportation, may be used for installation works.



Protect pipes and fittings against polluting (particularly with oil or grease).

Protect pipes and joints from the access of chemical substances (e.g. paint or organic solvents, steam containing chlorine).



min. +5 °C

A minimum temperature for plastic piping installation, as regards welding, is +5 °C. At lowers temperatures it is difficult to provide working conditions for high quality pipe joints.



Pipeline crossings are made by means of the components specially designed for this purpose.



Joining of plastic parts is done by polyfusion welding which results in a high-quality homogeneous joint.

Joining must be performed under specified working conditions with the use of appropriate tools.

It is not recommended to weld KAN-therm PP Green components together with other brand products (no warranty).



Components must not be exposed to open fire.



During storage, pipes and joints must not be exposed to sun rays (they must be protected against heat and UV rays).



Detailed information about storage and transport of components can be found at [en.kan-therm.com](http://en.kan-therm.com).

## 2.9 Safety

Pipes and fittings in KAN-therm PP Green system holds a set of necessary approvals and comply with current standards and normatives, which ensures long - lasting and trouble - free operation and full security of the installation. KAN-therm runs production in compliance with European EN ISO 15874, German standards DIN 8077, DIN 8078 and DVGW certificate.

- KAN-therm PP Green pipes complies with EN ISO 15874-2:2013 and positive hygienic result, German standards DIN 8077, DIN 8078 and DVGW certificate,
- KAN-therm PP Green fittings and valves complies with EN ISO 15874-3:2013 and positive hygienic result and DVGW certificate.
- System KAN-therm PP Green is granted with 10-years material warranty.
- Pipes and fittings of KAN-therm PP Green system also holds positive opinion of international certification units:









# SYSTEM KAN-therm PP Green - assortment

## Pipes

### Pipe PPR SDR7.4 PN16 - bar

GROUP: L

Size [mm]	*	Code			UM
20×2,8		2029203002	4	160	m
25×3,5		2029203004	4	100	m
32×4,4		2029203006	4	60	m
40×5,5		2029203008	4	40	m
50×6,9		2029203010	4	28	m
63×8,6		2029203012	4	16	m
75×10,3		2029203014	4	12	m
90×12,3		2029203016	4	8	m
110×15,1		2029203000	4	4	m



**Note:**

Application class 1; 8 bar.  
Application class 2; 6 bar.  
Application class 4; 10 bar.  
Application class 5; 6 bar.



### Pipe PPR SDR6 PN20 - bar

GROUP: L

Size [mm]	*	Code			UM
20×3,4		2029206018	4	120	m
25×4,2		2029206020	4	100	m
32×5,4		2029206022	4	60	m
40×6,7		2029206024	4	40	m
50×8,3		2029206026	4	28	m
63×10,5		2029206028	4	16	m
75×12,5		2029206030	4	12	m
90×15,0		2029206032	4	8	m
110×18,3		2029206014	4	4	m



**Note:**

Application class 1; 10 bar.  
Application class 2; 8 bar.  
Application class 4; 10 bar.  
Application class 5; 6 bar.



### Pipe PPR stabiAL SDR6 PN20 - bar

GROUP: M

Size [mm]	*	Code			UM
20×3,4		2029205002	4	100	m
25×4,2		2029205004	4	80	m
32×5,4		2029205006	4	40	m
40×6,7		2029205008	4	28	m
50×8,3		2029205010	4	20	m
63×10,5		2029205012	4	12	m
75×12,5		2029205014	4	8	m
90×15,0		2029205017	4	8	m
110×18,3		2029205016	4	4	m

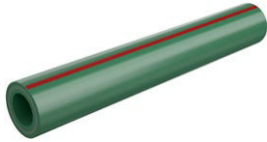
**Note:**

Application class 1; 10 bar.  
Application class 2; 8 bar.  
Application class 4; 10 bar.  
Application class 5; 6 bar.





 coil  bar  pipes in tube  bag  carton box  pallet **N** new **!** available soon

\* custom-made - lead time max 4 weeks | \*\* availability as agreed | \*\*\* while stock lasts



### Pipe PPR stabiGLASS SDR7.4 PN16 - bar

GROUP: M


Size [mm]	*	Code			UM
20×2,8		2029204007	4	200	m
25×3,5		2029204008	4	100	m
32×4,4		2029204009	4	60	m
40×5,5		2029204010	4	40	m
50×6,9		2029204011	4	20	m
63×8,6		2029204012	4	12	m
75×10,3		2029204013	4	8	m
90×12,3		2029204014	4	8	m
110×15,1		2029204006	4	4	m

**Note:**  
 Application class 1; 8 bar.  
 Application class 2; 6 bar.  
 Application class 4; 10 bar.  
 Application class 5; 6 bar.



### Pipe PPRCT stabiGLASS SDR9 PN16 - bar

GROUP: M

Size [mm]	*	Code			UM
125×14,0		2029206034	4	4	m

**Note:**  
 Application class 1; 10 bar.  
 Application class 2; 8 bar.  
 Application class 4; 8 bar.  
 Application class 5; 6 bar.



### Pipe PPRCT stabiGLASS SDR11 PN16 - bar

GROUP: M



Size [mm]	*	Code			UM
160×14,6		2029206035	4	4	m
200×18,2		2029206093	4	4	m

**Note:**  
 Application class 1; 8 bar.  
 Application class 2; 6 bar.  
 Application class 4; 6 bar.  
 Application class 5; 4 bar.

## Connectors

### PP/Push saddle

GROUP: N

Size [mm]	*	Code			UM
63 / 18x2,0		2009238035	20	160	pc.
75 / 18x2,0		2009238036	20	160	pc.
90 / 18x2,0		2009238037	20	160	pc.
110 / 18x2,0		2009238038	20	160	pc.



**Note:**

The external diameter of PP pipe is given to which the saddle is welded, as well as the connection pipe diameter.



### Female saddle

GROUP: N

Size [mm]	*	Code			UM
63 Rp½"		2009238024	20	100	pc.
75 Rp½"		2009238025	20	100	pc.
90 Rp½"		2009238026	20	100	pc.
110 Rp½"		2009238018	20	100	pc.


**Note:**

The external diameter of PP pipe is given to which the saddle is welded, as well as the diameter and type of thread.



### Looping compensation

GROUP: N

Size [mm]	*	Code		UM
20		2009036004	20	pc.
25		2009036005	15	pc.
32		2009036008	10	pc.


**Note:**

Loop diameter Ø150, length 370 mm.



### Crossover

GROUP: N



Size [mm]	*	Code		UM
20		2009269001	200	pc.
25		2009269004	130	pc.
32		2009269006	75	pc.





### Coupling



GROUP: N

Size [mm]	*	Code			UM
20		2009245007	100	700	pc.
25		2009245009	50	550	pc.
32		2009245011	40	280	pc.
40		2009245013	30	180	pc.
50		2009245015	10	110	pc.
63		2009245017	-	60	pc.
75		2009245019	-	45	pc.
90		2009245021	-	24	pc.
110		2009245002	-	16	pc.
125		2009245004	-	9	pc.



### Coupling reducer

GROUP: N



Size [mm]	*	Code			UM
 20 / 25		2009220122	50	550	pc.
 32 / 25		2009220123	40	280	pc.

 coil 
  bar 
  pipes in tube 
  bag 
  carton box 
  pallet 
  new 
  available soon

\* custom-made - lead time max 4 weeks | \*\* availability as agreed | \*\*\* while stock lasts

## Nipple reducer

GROUP: N

Size [mm]	*	Code			UM
25 / 20		2009220015	100	900	pc.
32 / 20		2009220017	80	640	pc.
32 / 25		2009220019	80	560	pc.
40 / 20		2009220021	50	400	pc.
40 / 25		2009220023	50	350	pc.
40 / 32		2009220025	50	300	pc.
50 / 20		2009220120	30	180	pc.
50 / 25		2009220000	30	120	pc.
50 / 32		2009220001	30	180	pc.
50 / 40		2009220027	30	150	pc.
63 / 25		2009220119	-	100	pc.
63 / 32		2009220029	-	100	pc.
63 / 40		2009220031	-	100	pc.
63 / 50		2009220033	-	100	pc.
75 / 50		2009220035	-	80	pc.
75 / 63		2009220037	-	50	pc.
90 / 50		2009220039	-	48	pc.
90 / 63		2009220041	-	45	pc.
90 / 75		2009220043	-	45	pc.
110 / 63		2009220003	-	27	pc.
110 / 75		2009220004	-	27	pc.
110 / 90		2009220005	-	27	pc.
125 / 110		2009220008	-	6	pc.
160 / 110		2009220009	-	2	pc.
160 / 125		2009220010	-	4	pc.
200 / 160		2009220114	-	1	pc.



**Note:**

Nipple reducers are intended for direct welding into the fitting socket from the bigger diameter side. The smaller diameter is intended for direct connection with the pipe.



## Female connector

GROUP: N

Size [mm]	*	Code			UM
20 Rp½"		2009245028	20	180	pc.
20 Rp¾"		2009245030	30	150	pc.
25 Rp½"		2009245032	20	160	pc.
25 Rp¾"		2009245034	30	150	pc.
25 Rp1"		2009245207	-	100	pc.
32 Rp¾"		2009245038	20	60	pc.
32 Rp1"		2009245036	20	60	pc.
40 Rp1¼"		2009245039	-	60	pc.
50 Rp1½"		2009245041	-	35	pc.
63 Rp2"		2009245043	-	18	pc.
75 Rp2½"		2009245045	-	12	pc.
90 Rp3"		2009245047	-	8	pc.

**Note:**

Elements with 1" thread and bigger have a polygon for a wrench.





### Male connector

GROUP: N

Size [mm]	*	Code			UM
20 R1/2"		2009245056	20	160	pc.
20 R3/4"		2009245058	30	120	pc.
25 R1/2"		2009245060	20	140	pc.
25 R3/4"		2009245062	20	100	pc.
25 R1"		2009245201	-	80	pc.
32 R1"		2009245064	20	60	pc.
32 R1 1/4"		2009245202	-	50	pc.
40 R1 1/4"		2009245067	-	50	pc.
50 R1 1/2"		2009245069	-	36	pc.
63 R2"		2009245071	-	18	pc.
75 R2 1/2"		2009245073	-	10	pc.
90 R3"		2009245075	-	6	pc.

**Note:**

Elements with 1" thread and bigger have a polygon for a wrench.



### Elbow 90°

GROUP: N

Size [mm]	*	Code			UM
20		2009068027	100	500	pc.
25		2009068029	50	350	pc.
32		2009068031	50	200	pc.
40		2009068033	20	120	pc.
50		2009068035	10	60	pc.
63		2009068037	-	32	pc.
75		2009068039	-	20	pc.
90		2009068041	-	12	pc.
110		2009068023	-	8	pc.
125		2009068021	-	1	pc.
160		2009068022	-	2	pc.
200		2009068215	-	1	pc.





### Nipple elbow 90°

GROUP: N

Size [mm]	*	Code			UM
20		2009068080	100	600	pc.
25		2009068081	50	400	pc.
32		2009068075	50	200	pc.

## Elbow 45°

GROUP: N

Size [mm]	*	Code			UM
20		2009068005	100	700	pc.
25		2009068007	50	400	pc.
32		2009068009	40	200	pc.
40		2009068011	20	140	pc.
50		2009068013	-	80	pc.
63		2009068015	-	40	pc.
75		2009068017	-	25	pc.
90		2009068019	-	14	pc.
110		2009068000	-	10	pc.
125		2009068001	-	4	pc.
160		2009068002	-	2	pc.
200		2009068214	-	1	pc.



## Nipple elbow 45°

GROUP: N

Size [mm]	*	Code			UM
20		2009068073	100	700	pc.
25		2009068074	50	450	pc.

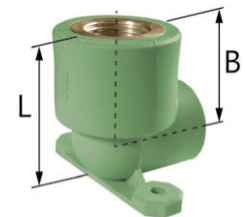


## Female directly fixed wallplate elbow - L = 45 mm

GROUP: N


Size [mm]	*	Code			UM
20 Rp1/2"		2009068085	20	140	pc.

**Note:**  
B = 29 mm.

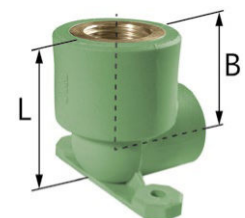


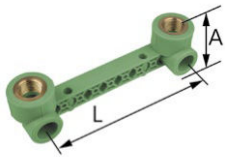
## Female directly fixed wallplate elbow - L = 57 mm

GROUP: N

Size [mm]	*	Code			UM
25 Rp1/2"		2009068086	20	120	pc.

**Note:**  
B = 36 mm.





### PP-R double female directly fixed wallplate elbow 90° - L = 148,5 mm

GROUP: N

Size [mm]	*	Code			UM
N 20 Rp½"		2009285000	1	30	pc.
N 25 Rp½"		2009285001	1	30	pc.

**Note:**  
20 Rp½" A = 45,5 mm  
25 Rp½" A = 50,7 mm



### Male elbow 90°

GROUP: N

Size [mm]	*	Code			UM
20 R½"		2009068058	30	90	pc.
20 R¾"		2009068060	30	90	pc.
25 R½"		2009068062	20	120	pc.
25 R¾"		2009068064	30	90	pc.
32 R¾"		2009068067	30	60	pc.
32 R1"		2009068066	15	45	pc.

**Note:**  
A fitting with 1" thread and bigger has a polygon for a wrench.



### Female elbow 90°

GROUP: N

Size [mm]	*	Code			UM
20 Rp½"		2009068045	20	140	pc.
20 Rp¾"		2009068047	30	120	pc.
25 Rp½"		2009068049	30	120	pc.
25 Rp¾"		2009068051	30	120	pc.
32 Rp¾"		2009068054	30	90	pc.
32 Rp1"		2009068053	15	45	pc.

**Note:**  
A fitting with 1" thread and bigger has a polygon for a wrench.



### Tee



GROUP: N

Size [mm]	*	Code			UM
20		2009257006	80	400	pc.
25		2009257008	20	240	pc.
32		2009257010	20	140	pc.
40		2009257012	15	75	pc.
50		2009257014	5	30	pc.
63		2009257016	-	24	pc.
75		2009257018	-	15	pc.
90		2009257020	-	10	pc.
110		2009257000	-	6	pc.
125		2009257002	-	1	pc.
160		2009257005	-	1	pc.
200		2009257096	-	1	pc.



## Reducing tee



GROUP: N

Size [mm]	*	Code			UM
25 / 20 / 20		2009260013	20	200	pc.
25 / 25 / 20		2009260016	20	200	pc.
25 / 20 / 25		2009260000	20	240	pc.
32 / 20 / 20		2009260021	20	200	pc.
32 / 20 / 32		2009260022	20	140	pc.
32 / 25 / 25		2009260024	20	140	pc.
32 / 25 / 32		2009260025	20	140	pc.
40 / 20 / 40		2009260028	20	80	pc.
40 / 25 / 40		2009260029	15	90	pc.
40 / 32 / 40		2009260031	15	90	pc.
50 / 20 / 50		2009260034	-	60	pc.
50 / 25 / 50		2009260035	-	65	pc.
50 / 32 / 50		2009260036	-	60	pc.
50 / 40 / 50		2009260039	-	50	pc.
63 / 25 / 63		2009260040	-	24	pc.
63 / 32 / 63		2009260042	-	30	pc.
63 / 40 / 63		2009260044	-	22	pc.
63 / 50 / 63		2009260046	-	22	pc.
75 / 40 / 75		2009260002	-	17	pc.
75 / 50 / 75		2009260139	-	16	pc.
75 / 63 / 75		2009260140	-	16	pc.
90 / 50 / 90		2009260049	-	12	pc.
90 / 63 / 90		2009260051	-	10	pc.
90 / 75 / 90		2009260053	-	12	pc.
110 / 63 / 110		2009260003	-	8	pc.
110 / 75 / 110		2009260143	-	8	pc.
110 / 90 / 110		2009260141	-	8	pc.
125 / 110 / 125		2009260004	-	3	pc.
160 / 90 / 160		2009260008	-	1	pc.
160 / 110 / 160		2009260007	-	1	pc.
200 / 90 / 200		2009257097	-	1	pc.
200 / 110 / 200		2009257098	-	1	pc.
200 / 125 / 200		2009257099	-	1	pc.
200 / 160 / 200		2009257100	-	1	pc.



## Side outlet tee

GROUP: N

Size [mm]	*	Code			UM
20		2009257037	40	360	pc.



## Cross

GROUP: N

Size [mm]	*	Code			UM
20		2009057002	40	320	pc.
25		2009057007	20	140	pc.



 coil 
  bar 
  pipes in tube 
  bag 
  carton box 
  pallet 
  new 
  available soon

\* custom-made - lead time max 4 weeks | \*\* availability as agreed | \*\*\* while stock lasts



### Male tee

GROUP: N

Size [mm]	*	Code			UM
20 Rp $\frac{1}{2}$ "		2009257035	20	120	pc.
N 25 Rp $\frac{1}{2}$ "		2009257108	30	90	pc.
N 25 Rp $\frac{3}{4}$ "		2009257111	30	90	pc.



### Female tee

GROUP: N

Size [mm]	*	Code			UM
20 Rp $\frac{1}{2}$ "		2009257024	20	120	pc.
20 Rp $\frac{3}{4}$ "		2009257026	30	90	pc.
25 Rp $\frac{1}{2}$ "		2009257028	20	180	pc.
25 Rp $\frac{3}{4}$ "		2009257030	30	180	pc.
32 Rp $\frac{3}{4}$ "		2009257033	15	60	pc.
32 Rp1"		2009257032	15	60	pc.

**Note:**  
An element with 1" thread has a polygon for a wrench.



### Union

GROUP: N

Size [mm]	*	Code			UM
20 G $\frac{3}{4}$ "		2009065000	20	200	pc.



### Female half union with flat sealing

GROUP: N

Size [mm]	*	Code			UM
20 G $\frac{3}{4}$ "		2009105002	50	400	pc.
25 G1"		2009105004	20	100	pc.
N 32 G1 $\frac{1}{4}$ "		2009105013	10	100	pc.



### Female half union with flat sealing

GROUP: N

Size [mm]	*	Code			UM
20 Rp $\frac{1}{2}$ "		2009271041	20	200	pc.
20 Rp $\frac{3}{4}$ "		2009271042	20	200	pc.
25 Rp $\frac{3}{4}$ "		2009271043	20	200	pc.



### Female union

GROUP: N

Size [mm]	*	Code			UM
N 20 G $\frac{1}{2}$ "		2009271052	20	200	pc.
N 25 G $\frac{3}{4}$ "		2009271055	20	100	pc.
N 32 G1"		2009271058	20	80	pc.

coil bar pipes in tube bag carton box pallet **N** new available soon

\* custom-made - lead time max 4 weeks | \*\* availability as agreed | \*\*\* while stock lasts

## Male union



GROUP: N

Size [mm]	*	Code			UM
20 G½"		2009271002	20	200	pc.
20 G¾"		2009271004	20	200	pc.
25 G¾"		2009271008	20	100	pc.
25 G1"		2009271006	20	100	pc.
32 G1"		2009271010	20	60	pc.



## Flange adapter

GROUP: N

Size [mm]	*	Code			UM
40		2009091012	1	40	pc.
50		2009091013	1	30	pc.
63		2009091014	1	20	pc.
75		2009091015	1	15	pc.
90		2009091016	1	10	pc.
110		2009091011	1	6	pc.
125		2009245079	-	2	pc.
160		2009245080	-	2	pc.
200		2009245209	-	1	pc.




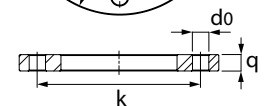
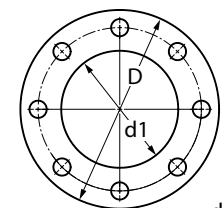
**Note:**

The flange adapter is delivered with an EPDM seal.

## Steel flange PN16

GROUP: N

Size [mm]	*	Code		UM
40		1209091002	1	pc.
50		1209091003	1	pc.
63		1209091004	1	pc.
75		1209091005	1	pc.
90		1209091006	1	pc.
110		1209091001	1	pc.
125		2009091000	1	pc.
160		2009091001	1	pc.
200		2009025056	1	pc.



Code	DN	D	d1	k	d0	q	N
1209091002	32	140	43	100	18	18	4
1209091003	40	150	53	110	18	18	4
1209091004	50	165	66	125	18	20	4
1209091005	65	185	78	145	18	20	8
1209091006	80	200	95	160	18	20	8
1209091001	100	220	114	180	18	22	8
2009091000	100	220	135	180	18	18	8
2009091001	150	285	178	240	22	24	8
2009025056	200	340	235	295	22	24	8

 coil  bar  pipes in tube  bag  carton box  pallet **N** new  available soon

\* custom-made - lead time max 4 weeks | \*\* availability as agreed | \*\*\* while stock lasts



### Bend 90°

GROUP: N

Size [mm]	*	Code			UM
20		2009011002	30	300	pc.
25		2009011000	20	180	pc.
32		2009011001	15	180	pc.



### Electrofusion coupling

GROUP: N

Size [mm]	*	Code			UM
20		2009088005	20	120	pc.
25		2009088006	20	120	pc.
32		2009088007	20	120	pc.
40		2009088008	10	30	pc.
50		2009088001	5	20	pc.
63		2009088002	5	15	pc.
75		2009088003	4	8	pc.
90		2009088004	2	8	pc.
110		2009088000	1	4	pc.
125		2009245001	-	1	pc.
160		2009245000	-	1	pc.
200		2009088036	-	1	pc.



### Stop end

GROUP: N

Size [mm]	*	Code			UM
20		2009025006	200	1000	pc.
25		2009025008	100	700	pc.
32		2009025010	50	500	pc.
40		2009025012	50	250	pc.
50		2009025014	-	170	pc.
63		2009025016	-	80	pc.
75		2009025018	-	50	pc.
90		2009025020	-	30	pc.
110		2009025000	-	20	pc.
125		2009025002	-	10	pc.
160		2009025005	-	8	pc.
200		2009025055	-	1	pc.



### Ball valve

GROUP: N

Size [mm]	*	Code			UM
20		2009278001	10	90	pc.
25		2009278002	10	50	pc.
32		2009278003	5	25	pc.
40		2009278005	5	15	pc.
50		2009278006	2	10	pc.
63		2009277002	2	8	pc.
75		2009277003	1	5	pc.

coil bar pipes in tube bag carton box pallet **N** new available soon

\* custom-made - lead time max 4 weeks | \*\* availability as agreed | \*\*\* while stock lasts

## Globe valve

GROUP: N

Size [mm]	*	Code			UM
20		2009280006	1	30	pc.
25		2009280008	1	30	pc.
32		2009280010	1	30	pc.



## Concealed globe valve with a knob

GROUP: N

Size [mm]	*	Code			UM
20		2009280000	1	30	pc.
25		2009280002	1	40	pc.
32		2009280004	1	20	pc.
40		2009277004	5	15	pc.
63		2009277005	1	20	pc.



**Note:**

The valves are delivered in a set with two plastic clips to mark hot (red) or cold (blue) water.



## Concealed globe valve with masking

GROUP: N

Size [mm]	*	Code			UM
20		2009280015	1	30	pc.
25		2009280016	1	30	pc.
32		2009280017	1	30	pc.



## Accessories



### Pipe clip

GROUP: N

Size [mm]	*	Code			UM
20		2009107025	20	800	pc.
25		2009107026	20	700	pc.
32		2009107027	20	440	pc.
40		2009107028	20	300	pc.
50		2009107030	20	240	pc.
63		2009107031	20	120	pc.
75		2009107032	20	100	pc.
90		2009107033	10	60	pc.

**Note:**  
Use only as sliding points.



### Single pipe clamp with rubber insert

GROUP: A

Size [mm]	*	Code		UM
20-23		1700081028	100	pc.
25-28		1700081029	100	pc.
32-36		1700081030	50	pc.
40-44		1700081031	50	pc.
47-52		1700081032	50	pc.
57-63		1700081034	50	pc.
74-78		1700081035	25	pc.
85-91		1700081036	25	pc.
108-112		1700081023	25	pc.
125		2009107075	20	pc.
160		2009107076	10	pc.
200		2009107077	10	pc.

**Note:**  
The clamp has a double-threaded screw with a collar (8x70) a plastic dowel (Ø12) in the set.



### Double pipe clamp with rubber insert

GROUP: A

Size [mm]	*	Code		UM
20-23		1700081020	50	pc.
25-28		1700081021	50	pc.
32-36		1700081022	50	pc.

**Note:**  
The clamp has a double-threaded screw with a collar (8x70) a plastic dowel (Ø12) in the set.



### Mounting plate

GROUP: N

Size [mm]	*	Code			UM
L = 150		2009210000	30	150	pc.

Mounting plate 150 mm - plate total length 215 mm, width 64 mm, depth 6 mm.

coil bar pipes in tube bag carton box pallet **N** new available soon

\* custom-made - lead time max 4 weeks | \*\* availability as agreed | \*\*\* while stock lasts

## Tools

### Scraper for stabiAL pipes


GROUP: K

Size [mm]	*	Code		UM
20 / 25		1933267043	1	pc.
25 / 32		1933267045	1	pc.
32 / 40		1933267047	1	pc.
50		1933267049	1	pc.
63		1933267051	1	pc.
75		1933267053	1	pc.
90		1933267055	1	pc.
110		1933267039	1	pc.



### Blade for stabiAL pipe scraper

GROUP: K

	*	Code		UM
	*	1933267035	1	pc.



### Cutter for pipes


GROUP: K

Range [mm]	*	Code		UM
20-40		1933267029	1	pc.



### Roll-cutter for PP pipes


GROUP: K

Range [mm]	*	Code		UM
50-110		1933267032	1	pc.



### Pipe cutting machine

GROUP: K


Range [mm]	*	Code		UM
50-200		1948267034	1	pc.

**Note:**  
The set does not include a cutting wheel.



### Pipe support for cutting machine

GROUP: K

	*	Code		UM
		1948267029	1	pc.



 coil  bar  pipes in tube  bag  carton box  pallet  new  available soon

\* custom-made - lead time max 4 weeks | \*\* availability as agreed | \*\*\* while stock lasts



### Wheel for cutting machine


GROUP: K

Range [mm]	*	Code		UM
125-200		1933267072	1	pc.



### Stationery welding machine

GROUP: K

Range [mm], power [W]	*	Code		UM
63-110, 1600		1933267036	1	pc.


- Each set includes:
- welding device PZ-125,
  - welding machine 1600 W,
  - 1933345003 - jaws PZ-125 for 63 mm pipes,
  - 1933345002 - jaws PZ-125 for 75 mm pipes,
  - 1933345001 - jaws PZ-125 for 90 mm pipes,
  - 1933345000 - jaws PZ-125 for 110 mm pipes,
  - case.

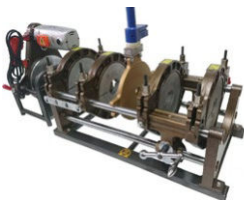
**Note:**  
The set does not include heating sockets!



### Electrofusion welding machine

GROUP: K

Range [mm], power [W]	*	Code		UM
20-200, 3000		1933267071	1	pc.



### Butt-welding machine

GROUP: K

Range [mm], power [W]	*	Code		UM
90-200, 2200		1933267073	1	pc.



### KAN-therm welding set

GROUP: K

Range [mm], power [W]	*	Code		UM
<b>N</b> 20-50, 800		1933267078	1	pc.
<b>N</b> 63-125, 1600		1933267079	1	pc.


- Each set includes:
- Electric welding machine 800 W or 1600 W
  - Rack for the welding machine
  - Bolt for fastening heating sockets
  - Metal case
  - Set of heating inserts 16-50 mm or 63-110 mm

**Note:**  
The set does not include heating sockets for saddle fittings!



## Welding device RITMO PRISMA JIG

GROUP: K

Range [mm]	*	Code		UM
63-125		1933267081	1	pc.

**Note:**  
Tool is sold in set with case.



## Welding device SPIDER 125 McElroy

GROUP: K


Range [mm]	*	Code		UM
63-125		1933267082	1	pc.

**Note:**  
Tool is sold in set with case.



## Screw for welding machine

GROUP: K


	*	Code		UM
		1933267037	1	pc.

**Note:**  
Bolt for heating sockets - service part.



## Heating sockets for saddle fittings

GROUP: K


Size [mm]	*	Code		UM
40		1933267004	1	pc.
50		1933267005	1	pc.
63		1933267006	1	pc.
75		1933267007	1	pc.
90		1933267008	1	pc.
110		1933267002	1	pc.

**Note:**  
The set includes a female and male socket and a mounting bolt (Allen).  
Heating sockets for saddle fittings are not included in heating sets (1933267078, 1933267079).



## Drill bit for mounting saddle fittings

GROUP: K


Size [mm]	*	Code		UM
25		1933267038	1	pc.





### Reamer for pipe stabil for mounting saddle fittings


GROUP: K

Size [mm]	*	Code		UM
25		1933267074	1	pc.



### Heating sockets

GROUP: K

Size [mm]	*	Code		UM
20		1933267013	1	pc.
25		1933267015	1	pc.
32		1933267017	1	pc.
40		1933267019	1	pc.
50		1933267021	1	pc.
63		1933267023	1	pc.
75		1933267025	1	pc.
90		1933267027	1	pc.
110		1933267009	1	pc.

 coil 
  bar 
  pipes in tube 
  bag 
  carton box 
  pallet 
  new 
  available soon

\* custom-made - lead time max 4 weeks | \*\* availability as agreed | \*\*\* while stock lasts



Install your **future**



SYSTEM **KAN-therm**

**Inox**

Prestigious material,  
Giga possibilities

EN 24/07

Ø 15–168,3 mm

### 3 SYSTEM **KAN-therm** Inox

<b>3.1</b>	<b>General information</b> .....	<b>101</b>
<b>3.2</b>	<b>System KAN-therm Inox</b> .....	<b>102</b>
	Pipes and fittings – characteristics .....	<b>102</b>
	Pipe diameters, lengths, weight and capacity .....	<b>102</b>
	Scope of use .....	<b>103</b>
<b>3.3</b>	<b>Sealants – O-Rings</b> .....	<b>104</b>
<b>3.4</b>	<b>Durability, resistance to corrosion</b> .....	<b>105</b>
	Internal corrosion .....	<b>106</b>
	External corrosion .....	<b>108</b>
<b>3.5</b>	<b>Technique of Press joints</b> .....	<b>109</b>
	Tools .....	<b>109</b>
	Preparation of pipes for pressing .....	<b>116</b>
	Pipe bending .....	<b>122</b>
	Threaded fittings, connecting with other KAN-therm systems .....	<b>122</b>
<b>3.6</b>	<b>Flange connections</b> .....	<b>123</b>
<b>3.7</b>	<b>Ball valves of KAN-therm Inox system</b> .....	<b>124</b>
	Service and maintenance .....	<b>125</b>
<b>3.8</b>	<b>Operational notes</b> .....	<b>125</b>
	Equipotential bonding .....	<b>125</b>
<b>3.9</b>	<b>Transport and storage</b> .....	<b>126</b>

#### System **KAN-therm** Inox - assortment

Pipes .....	<b>127</b>
Connectors .....	<b>128</b>
Accessories .....	<b>141</b>
Tools .....	<b>143</b>

## 3 SYSTEM KAN-therm Inox

### 3.1 General information

KAN-therm Inox is complete, state-of-the-art installation system consisting of precise pipes and fittings manufactured out of high quality stainless steel. Assembly bases on the "Press" technique, in which fittings are radially pressed over the pipe. Special pressure seals (O-Rings) provide tightness of joints. O-Rings are made of high quality synthetic rubber resistant to high temperatures. A three-angle type "M" pressing system, guarantees reliable, uninterrupted operation of the system. Inox system is used in indoor installations (new and renovated) in housing estates, public buildings and industrial facilities.

KAN-therm Inox system is characterized by:

- easy and quick assembly, without the use of open flame,
- large scope of diameters of pipes and fittings, from 12 to 168,3 mm,
- broad working temperature tolerance: from -35 °C to 135 °C (200 °C after exchanging standard seals),
- resistance to high pressure, up to 25 bar (for water-filled installations),
- low pressure drops in pipes and fittings,
- possibility of connecting with plastic KAN-therm systems,
- low weight of pipes and fittings,
- resistance to mechanical loads,
- no fire threat during assembly and use (reaction to fire class A),
- esthetic value of installations,
- signaling of mistakenly not-pressed joints in the installation.

## 3.2 System KAN-therm Inox

### Pipes and fittings – characteristics

Pipes (precise, thin-walled with longitudinal seam out of) are made of thin-walled alloy steel, chromium-nickel-molybdenum X5CrNiMo 17 12 2 No. 1.4401, AISI 316 or X2CrNiMo 17 12 2 No. 1.4404, AISI 316L or X2CrMoTi18-2 No. 1.4521, AISI 444.

Fittings are made of chromium-nickel-molybdenum steel No. 1.4404, AISI 316L. Molybdenum content (min. 2,2%) determines the pipe's high resistance to corrosion. According to Directive EU 98, inclusion of nickel in the alloy does not result in exceeding the permissible values of nickel content in potable water  $\leq (0,02 \text{ mg/l})$ .

Fittings are offered with pressed ends and O-Ring seals, or with pressed and threaded ends with female or male threads, according to EN 10226-1.

### Physical properties of 1.4401, 1.4404, 1.4521 KAN-therm Inox pipes

Property	Symbol	Unit	Value	Remarks
Linear elongation coefficient	$\alpha$	mm/m $\times$ K	0,0166	$\Delta t = 1 \text{ K}$
Thermal conductivity	$\lambda$	W/m $\times$ K	15	
Minimal bending radius	$R_{\min}$		$3,5 \times D_e$	max. diameter 28 mm
Internal wall roughness	k	mm	0,0015	

### Pipe diameters, lengths, weight and capacity

Scope of diameters  $\varnothing 15$  to  $\varnothing 168,3$  mm for wall thickness from 1,0 to 2 mm. Pipe length 6 m  $\pm$  50 mm, end-capped.

### Dimensions, weight by unit, water capacity of standard KAN-therm Inox pipes (1.4404)

DN	External diameter $\times$ Wall thickness	Wall thickness	Internal diameter	Weight by unit	Length of the bar	Capacity by unit
	mm $\times$ mm	mm	mm	kg/m	m	l/m
12	15 $\times$ 1,0	1,0	13,0	0,352	6	0,133
15	18 $\times$ 1,0	1,0	16,0	0,427	6	0,201
20	22 $\times$ 1,2	1,2	19,6	0,627	6	0,302
25	28 $\times$ 1,2	1,2	25,6	0,808	6	0,515
32	35 $\times$ 1,5	1,5	32,0	1,263	6	0,804
40	42 $\times$ 1,5	1,5	39,0	1,527	6	1,195
50	54 $\times$ 1,5	1,5	51,0	1,979	6	2,042
65	76,1 $\times$ 2,0	2,0	72,1	3,725	6	4,080
80	88,9 $\times$ 2,0	2,0	84,9	4,368	6	5,660
100	108 $\times$ 2,0	2,0	104,0	5,328	6	8,490
125	139,7 $\times$ 2,0	2,0	135,7	7,920	6	14,208
150	168,3 $\times$ 2,0	2,0	164,3	9,541	6	20,893

## Dimensions, weight by unit, water capacity of standard KAN-therm Inox pipes (1.4401 and 1.4521)

DN	External diameter × Wall thickness	Wall thickness	Internal diameter	Weight by unit	Length of the bar	Capacity by unit
	mm × mm	mm	mm	kg/m	m	l/m
12	15 × 1,0	1,0	13,0	0,352	6	0,133
15	18 × 1,0	1,0	16,0	0,427	6	0,201
20	22 × 1,2	1,2	19,6	0,627	6	0,302
25	28 × 1,2	1,2	25,6	0,808	6	0,514
32	35 × 1,5	1,5	32,0	1,263	6	0,804
40	42 × 1,5	1,5	39,0	1,527	6	1,194
50	54 × 1,5	1,5	51,0	1,979	6	2,042
65	76,1 × 2,0	2,0	72,1	3,725	6	4,080
80	88,9 × 2,0	2,0	84,9	4,368	6	5,660
100	108 × 2,0	2,0	104,0	5,328	6	8,490

The scope of application of the KAN-therm Inox installation in the construction industry is determined by the applicable standards and the National Technical Assessment ITB - permissible operating pressure up to 25 bar, medium: water and maximum temperature 135 °C:

Operating pressure of the KAN-therm Inox system depends on the range of diameters, installation medium and press tools used for performing connections.

When using standard "M" profile press tools, the permissible working pressure is 16 bar for diameters 12 – 168,3 mm.

When using Novopress press tools equipped with jaws and collars in "HP" profile, and using 1.4401 grade stainless steel pipes (look at Inox Spinkler offer in Specialized Installations catalog), the permissible working pressure is 25 bar for diameters 12 – 108 mm.

Working pressure of 25 bar does not include KAN-therm Inox ball valves and axial compensators. Working pressure of 25 bar includes installations filled with water. If using other media, contact KAN Technical Department.



**Notice: Test pressure can not exceed 25 bar during pressure tightness test.**

With Viton O-Rings, continuous operation of the installation is possible in the temperature range -30 °C - 200 °C, also in the case of non-typical media.

### Scope of use

- heating installations,
- hot and cold tap water installations,
- treated water installations (desalinated, softened, decarbonated, deionized, demineralized and distilled),
- open and closed heating systems (water, glycol),
- open and closed chilled water installations (max. dissolved chloride contents 250 mg/l),
- solar installations (Viton O-Rings – working temperature up to 200 °C),
- fuel oil installations (Viton O-Rings),
- compressed air installations (details in "compressed air installations in KAN-therm system"),
- condensate installations applying the condensation technique for gas fuels (pH 3.5 to 5.2),
- technological installations in the industry.

The use of KAN-therm Inox pipes and fittings outside the scope of indoor water supply and heating installations, e.g. for media of non-typical chemical contents should be consulted with KAN's Technical Department (available questionnaire); Please provide i. a. the chemical content of the medium, maximum temperature and operating pressure, as well as ambient temperature in the questionnaire.



Exemplary KAN-therm Inox installation

### 3.3 Sealants – O-Rings

KAN-therm Inox pressed fittings are, by standard, equipped with O-Rings made of ethylene-propylene EPDM rubber observing the requirements of EN 681-1. In the case of special applications, Viton O-Rings may be supplied. Working parameters and scopes of use are presented in the table.

Material	Color	Working parameters	Use
<b>EPDM ethylene-propylene rubber</b>	black	<ul style="list-style-type: none"> <li>■ max working pressure: 16 or 25 bar (depending on the used tools, diameter range and transported medium)</li> <li>■ working temperature: -35 °C to +135 °C</li> <li>■ short-term: +150 °C</li> </ul>	installations: <ul style="list-style-type: none"> <li>■ potable water</li> <li>■ hot water</li> <li>■ central heating</li> <li>■ conditioned water</li> <li>■ glycol solutions*</li> <li>■ fire fighting</li> <li>■ compressed air (with no oil**)</li> </ul>
<b>FPM/Viton fluoride rubber</b>	green	<ul style="list-style-type: none"> <li>■ max working pressure: 16 or 25 bar (depending on the used tools, diameter range and transported medium)</li> <li>■ working temperature: -20 °C to +200 °C</li> <li>■ short-term: +230 °C</li> </ul>	installations: <ul style="list-style-type: none"> <li>■ solar</li> <li>■ compressed air</li> <li>■ fuel oil</li> <li>■ fuel</li> <li>■ with vegetable fat</li> <li>■ glycol solutions*</li> </ul> <b>Notice:</b> Do not use in potable water and pure hot water installations.

\* It is permissible to use antifreeze solutions based on ethylene and propylene glycols with a maximum concentration of up to 50%, which have been approved by KAN in writing.

\*\* Maximum concentration of synthetic oils up to 5 mg/m<sup>3</sup>; mineral oils not allowed.



The possibility of using Viton O-Rings should be consulted with KAN's Technical Department.

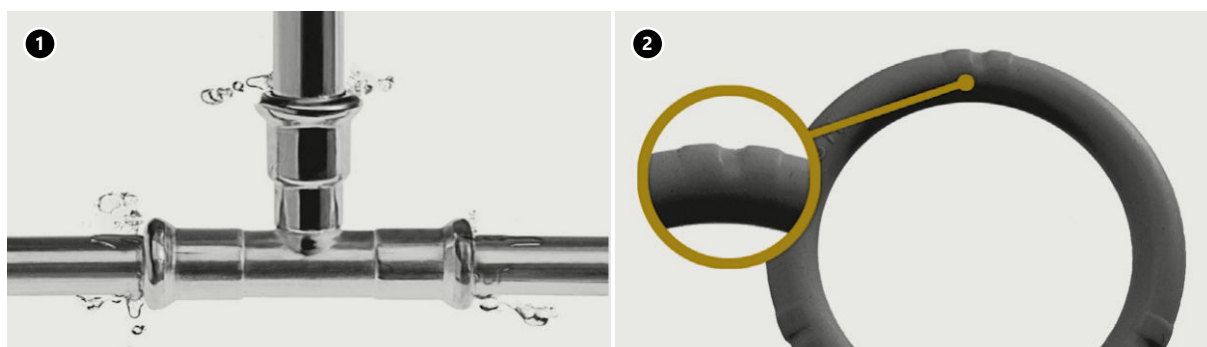
Both in the case of EPDM and Viton O-Rings, the use of glycol solutions (ethylene and propylene) is allowed as long as they are approved in writing by the manufacturer of the installation system.

In order to facilitate mounting O-Rings in Inox fittings are covered with talcum powder (all diameters). If, however, the use of another lubricant proves necessary, use water or soap. Do not cover O-Rings with grease, oil or fat. These substances might damage the joints. This also refers to contact with some types of paint used to cover pipes and fittings. Therefore, if the painting of installation is necessary, use O-Ring Viton to seal the connections. When standard EPDM O-Rings are used, only water-based paints are allowed.

The durability of KAN-therm Inox O-Rings has been tested and proven by the DVGW institute. According to test results, the life span of an O-Ring should be no shorter than 50 years.

KAN-therm Inox fittings up to 54 mm are equipped with special LBP O-Rings which guarantees quick detection of not-pressed joints in the installation during the preliminary stage of connecting to water supply (LBP function – Leak Before Press). Such joints are signaled by water leaks at a point of connection. This useful function results from the unique structure of O-Rings having 3 special notches on the circumference. To ensure a fully functional and tight joint, after locating the leak, just press the joint.

For elements above 54 mm, LBP function is performed by fitting specific shape.



1. O-Ring action with the LBP function of leakage detection
2. LBP O-Rings with a function of leakage detection

### 3.4 Durability, resistance to corrosion

Installation technology distinguishes various types of corrosion: chemical, electrochemical, internal or external, spot corrosion, corrosion produced by stray currents, etc. Such phenomena may be caused by specific physical and chemical factors related to the quality of installation materials, parameters of conducted media, external conditions, as well as the structure of the installation. Below, we present a few guidelines to be taken into account when designing, assembling and using KAN-therm Inox installations in order to avoid undesirable corrosive phenomena in metal installations.

The probability of occurrence of metal corrosion caused by stray currents (direct current passing through the pipeline material to the ground, disrupting the natural insulation layers, such as walls, pipe shields, etc.) is very small. This phenomenon is additionally reduced by introducing equipotential connections to the installation.

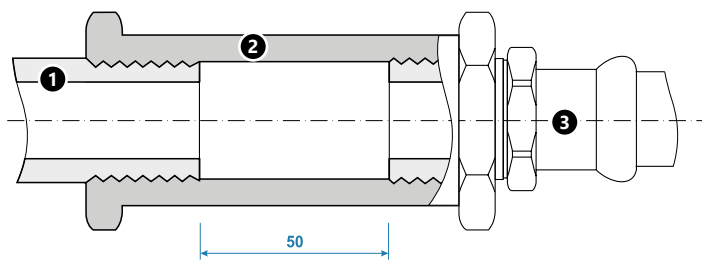
## Internal corrosion

KAN-therm Inox pipes and fittings are perfect for transporting potable water (both cold and hot). They may also be used with treated water (softened, deionized, distilled), even water with conductivity below 0,1  $\mu\text{S}/\text{cm}$ .

Stainless steel is resistant to nearly all components of the media transported in installations. Pay special attention to chlorides dissolved in water (halogens), since their action depends on their concentration and temperature (max 250 mg/l at 20 °C). No elements should be subjected to contact with highly concentrated ions of dissolved chlorides in temperatures above 50 °C. This is why you should:

- avoid sealants containing halogens which could dissolve in water (use plastic sealing tape, e.g. PARALIQ PM 35),
- avoid contact with oxygenated water with high chloride content (potable water with up to 0,6 mg/l chlorine content does not cause any adverse phenomena, the maximum permitted chlorine content in potable water is 0,3 mg/l). Water installations in the Inox system may be disinfected with a chlorine solution on the condition that its concentration in water does not exceed 1,34 mg/l, and that the installation is flushed twice after disinfection,
- local water heating by increased pipe wall temperature (e.g. heating cables in water supply installations) may lead to the precipitation of sediments on the internal surface of pipes, including chloride ions, which increase the risk of pit corrosion. In such case, the temperature of pipe wall should not exceed 60 °C permanently. Periodic (max 1 hour a day) water heating up to 70 °C for the purpose of thermal disinfection is permissible.

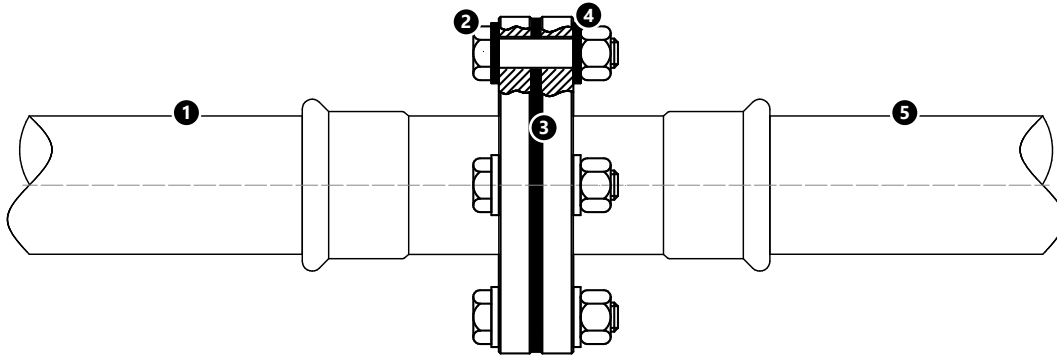
Direct connections of stainless steel elements with zinc-plated steel (fixtures, fittings) may result in contact corrosion of zinc-plated steel. Therefore, a bronze or brass element (e.g. coupling) of at least 50 mm must be used.



Principle of connecting KAN-therm Inox elements with zinc-plated steel

1. Steel pipe zinc-plated
2. Bronze or brass
3. Fitting with a KAN-therm Inox thread

It is also acceptable to make separable flange connections:



**Case I:**

1. KAN-therm Inox system,
2. stainless steel flange bolt and nut
3. elastomer or fibre sealing
4. metal washer with plastic casing
5. Traditional carbon steel system.

**Case II:**

1. KAN-therm Inox system,
2. stainless steel flange bolt and nut
3. elastomer or fibre sealing
4. metal washer with plastic casing
5. Traditional copper system.



**Remember that all of the above flange connections use bolts and nuts joining flanges made of stainless steel.**

In water supply systems, remember of the liquid flow direction (the more corrosion-resistant metal should be placed behind the less corrosion-resistant metal, when looking in the direction of flow). That rule does not apply to closed liquid circuits.

In KAN-therm Inox system, the is a possibility of using other materials (with intermediate elements, such as threaded or collar joints) depends on the type of installation.

## Possibility of connecting KAN-therm Inox system with other elements

Installation type		Pipes/fittings			
		Copper	Bronze/Brass	Carbon steel	Stainless steel
Inox	closed	yes	yes	yes	yes
	open	yes	yes	no	yes

## External corrosion

External corrosion of elements of the KAN-therm Inox system can occur when pipes or fittings are in a humid environment containing or producing compounds of chlorine or other halogens. Corrosion processes are intensified at temperatures above 50 °C.

In addition, elements of the KAN-therm Inox system can be installed and operated in environments with a corrosivity class no higher than C3 according to EN ISO 12944-2.

Therefore, in situations:

- contact with building components (e.g. mortar, insulation) emitting chlorine compounds,
- environment containing chlorine or its compounds in gaseous form or water containing salt (brine) or other halogen compounds,
- the use of the KAN-therm Inox system in an environment with a corrosivity class of C4 and higher,

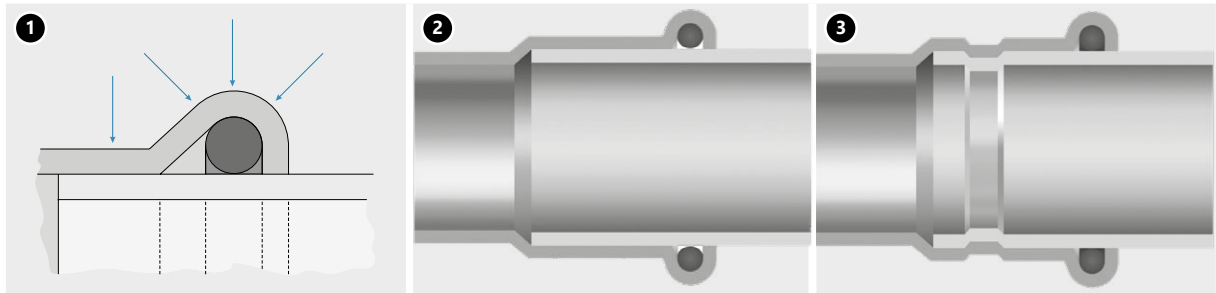
it is necessary to use full, watertight and non-absorbent waterproofing made of material with a closed cell structure that does not emit chlorides and halides.

If there is a risk of mechanical damage to the external insulations then these must be adequately protected, for example, with protective steel coating.

### 3.5 Technique of Press joints

KAN-therm Inox system is based on the "Press" technique of executing joints, utilizing M-profiled jaws. This technique allows:

- applying three-angle pressure on the O-Ring, which ensures its correct deformation and adhesion to the pipe surface,
- fully enclosing the inner space, in which the O-Ring is settled – through screwing the edge of the fitting onto the surface of the pipe, which prevents pollutions from penetrating the interior of the fitting. Such structure serves as a natural mechanic shield to the seal and reinforcement to the joint,
- controlling the state of the joint through the structure of the O-Ring socket in the vicinity of the fitting edge.



1. Pressure directions in a "Press" joint  
 2. Cross-section of a joint before pressing  
 3. Cross-section of the joint after pressing

### Tools

In order to ensure a correct, water-tight connection, use proper tools. We suggest the use of cutters, deburrers and press machines as well as jaws offered by the KAN-therm system. There is a possibility of using other tools recommended by KAN (see table below).

To perform connections in KAN-therm Inox, use tools available in KAN-therm system offer - see the table below.

Producer	Press type		Diameter [mm]	Jaws/collars		Adapter		Type of KAN-therm system	
	Description	Code		Description	Code	Description	Code	Inox	
KAN-therm	AC 3000 DC 4000	1936267239 1936267238	12	M	1936267248	-	-	+	
			15	M	1936267249	-	-	+	
			18	M	1936267250	-	-	+	
			22	M	1936267251	-	-	+	
			28	M	1936267252	-	-	+	
			35	M	1936267253	-	-	+	
			42	M	1936267283				+
			54	M	1936267284			ZBS1	1936267285

Producer	Press type		Diameter [mm]	Jaws/collars		Adapter		Type of KAN-therm system
	Description	Code		Description	Code	Description	Code	Inox
NOVOPRESS	ACO203XL EFP203 1)	1948267181 1948267210	12 <sup>1)</sup>	[J] M	1948267134	-	-	+
			15 <sup>1)</sup>	[J] M	1948267135	-	-	+
			18 <sup>1)</sup>	[J] M	1948267137	-	-	+
			22 <sup>1)</sup>	[J] M	1948267139	-	-	+
			28 <sup>1)</sup>	[J] M	1948267141	-	-	+
			35 <sup>1)</sup>	[J] M	1948267143	-	-	+
			35 <sup>1)</sup>	HP Snap On	1948267124			+
			42 <sup>1)</sup>	M Snap On	1948267119	ZB203	1948267000	+
			42 <sup>1)</sup>	HP Snap On	1948267126			+
			54 <sup>1)</sup>	M Snap On	1948267121			+
			66,7	M Snap On	1948267089			-
			76,1	M Snap On	1948267145	ZB221	1948267005	+
	88,9	M Snap On	1948267044			+		
	108	M Snap On	1948267038	ZB221 ZB222	1948267005 1948267007	+		
	ACO102 ACO103	1948055007 1948055008	15	[J] M	1948267093	-	-	+
			18	[J] M	1948267095	-	-	+
			22	[J] M	1942121002	-	-	+
			28	[J] M	1948267097	-	-	+
35			[J] M	1942121004	-	-	+	
ECO301 *	1948267163 *	12	[J] M	1948267084	-	-	-	
		15	[J] M	1948267085	-	-	+	
		18	[J] M	1948267087	-	-	+	
		22	[J] M	1944267008	-	-	+	
		28	[J] M	1944267011	-	-	+	
		35	HP Snap On	1948267124			+	
		42	HP Snap On	1948267126	ZB 303	1948267166	+	
54	HP Snap On	1948267128			+			
ACO401 ACO403	1948267151 1948267209	76,1	HP Snap On	1948267100	-	-	+	
		88,9	HP Snap On	1948267102	-	-	+	
		108	HP Snap On	1948267098	-	-	+	
		139,7	HP Snap On	1948267071	-	-	+	
		168,3	HP	1948267072	-	-	+	
REMS	Power-Press SE Akku-Press Power-Press ACC	1936267160 1936267152 1936267219	12	[J] M	1948267046	-	-	+
			15	[J] M	1948267048	-	-	+
			18	[J] M	1948267052	-	-	+
			22	[J] M	1948267056	-	-	+
			28	[J] M	1948267061	-	-	+
			35	[J] M	1948267065	-	-	+
			42	[J] M	1948267067	-	-	+
			54	[J] M	1948267069	-	-	+
KLAUKE	KAN-therm Mini	1936055008	15	M	1936267278	-	-	+
			18	M	1936267279	-	-	+
			22	M	1936267280	-	-	+
			28	M	1936267282	-	-	+
	UAP100*	1948267159*	76,1	KSP3	1948267080	-	-	+
			88,9	KSP3	1948267082	-	-	+
			108	KSP3	1948267074	-	-	+

[J] - two segment jaw, other elements are collars / slings and may require cooperation with an adapter.

1) Limited diameter range - use selected press jaws

\* The tools are not available in KAN-therm Inox offer.

To perform connections in KAN-therm Inox, other tools available on the market can also be utilized - see the table below.

Size	Manufacturer	Press type	Jaws/tongs
12–28 mm	Novopress	<ul style="list-style-type: none"> <li>Presskid (12 V)</li> </ul>	<ul style="list-style-type: none"> <li>Presskid: 12–28 mm jaws with inserts</li> </ul>
12–35 mm	Novopress	<ul style="list-style-type: none"> <li>ACO102 (12 V)</li> <li>ACO103 (12 V)</li> <li>AFP 101 (9,6 V)</li> </ul>	<ul style="list-style-type: none"> <li>PB1 jaws: 12–35 mm</li> </ul>
12–54 mm	Novopress	<ul style="list-style-type: none"> <li>ECO 1 Pressboy (230 V)</li> <li>ECO 201/202 (230 V)</li> <li>ACO 1 Pressboy (12 V)</li> <li>ACO 3 Pressmax (12 V)</li> <li>ACO 201 (14,4 V)</li> <li>ACO 202 (18 V)</li> <li>ACO 202XL (18 V)</li> <li>EFP 2 (230 V)</li> <li>EFP 201/202 (230 V)</li> <li>EFP203 (230 V)</li> <li>AFP 201/202 (14,4V)</li> </ul>	<ul style="list-style-type: none"> <li>PB2 jaws: 12–35 mm</li> <li>Collars and adapters 35–54 mm: <ul style="list-style-type: none"> <li>Collars: HP35, 42 and 54 (with adapter ZB 201/ZB 203)</li> <li>Snap On collars: HP35, 42 and 54 (with adapter ZB 201)</li> <li>Snap On collars: HP35, HP42 and HP54 (with adapter ZB 203)</li> </ul> </li> <li>Collars for ACO 3 Pressmax are compatible with ZB 302/ZB 303 adapter</li> <li>Collars: HP35, 42 and 54 (with adapter ZB 302/ZB 303)</li> <li>Collars Snap On: HP35, 42 and 54 (with adapter ZB 303)</li> </ul> <p><b>IMPORTANT:</b> The HP54 jaws may only be used for crimping stainless steel 1.4401 pipes (KAN-therm Inox Sprinkler).</p>
12–108 mm	Novopress	<ul style="list-style-type: none"> <li>ECO 3 Pressmax (230 V)</li> <li>ECO 301 (230 V)</li> </ul>	<ul style="list-style-type: none"> <li>PB3 jaws: 12–28 mm</li> <li>Collars and adapters (ZB 302/ZB 303) 35–54 mm: <ul style="list-style-type: none"> <li>Collars: HP35, 42 and 54 (with adapter ZB 302/ZB 303)</li> <li>Sling On collars: HP42 and HP54 (with adapter ZB 302)</li> <li>Snap On collars: HP35, HP42 and HP54 (with adapter ZB 303)</li> </ul> </li> <li>Collars and adapters 76,1–108 mm: <ul style="list-style-type: none"> <li>Collars M66,7–88,9 mm (ZB 323 adapter)</li> <li>Snap On collar M108 mm (two adapters required: ZB 323 and ZB 324)</li> <li>Sling On collars M76,1–88,9 mm (ZB321 adapter)</li> <li>Sling On collars M108 (two adapters required: ZB321 and ZB322)</li> </ul> </li> </ul> <p><b>IMPORTANT:</b> Press in two stages (108 mm).</p>
76,1–168 mm	Novopress	<ul style="list-style-type: none"> <li>Hydraulic-Press-System HCP /HA 5</li> <li>ACO 401 (18 V)</li> <li>ACO403 (18 V)</li> </ul>	<ul style="list-style-type: none"> <li>Snap On collars HP76,1–139,7 mm</li> <li>Sling On collars HP168,3 mm</li> </ul> <p><b>IMPORTANT:</b> Press in two stages (168,3 mm).</p>
12–28 mm	Klauke	<ul style="list-style-type: none"> <li>MAP1 "Klauke Mini" (9,6 V)</li> <li>MAP2L "Klauke Mini" (18 V)</li> </ul>	<ul style="list-style-type: none"> <li>Mini Klauke jaws: 12–28 mm (28 mm jaw marked as "Only VSH")</li> </ul>
12–54 mm	Klauke	<ul style="list-style-type: none"> <li>UAP2 (12 V)</li> <li>UNP2 (230 V)</li> <li>UP75 (12 V)</li> <li>UAP3L (18 V)</li> </ul>	<ul style="list-style-type: none"> <li>Jaws: 12–54 mm (KSP3)</li> <li>Collars and adapter: 42–54 mm (KSP3)</li> </ul> <p><b>IMPORTANT:</b> New M-Klauke Jaw kits (without pressing inserts) may be used as well as old M-Klauke Jaw kits (with pressing inserts).</p>
12–108 mm	Klauke	<ul style="list-style-type: none"> <li>UAP4 (12 V)</li> <li>UAP4L (18 V)</li> </ul>	<ul style="list-style-type: none"> <li>Jaws: 12–54 mm (KSP3)</li> <li>Collars and adapter: 42–54 mm (KSP3)</li> <li>Collars and adapters: 76,1–168 mm (LP – KSP3)</li> </ul>
66,7–108 mm	Klauke	<ul style="list-style-type: none"> <li>UAP100 (12 V)</li> <li>UAP100L (18 V)</li> </ul>	<ul style="list-style-type: none"> <li>Collars: 66,7–108 mm (KSP3)</li> </ul>
12-35 mm	Hilti	<ul style="list-style-type: none"> <li>NPR 019 IE-A22</li> </ul>	<ul style="list-style-type: none"> <li>NPR PM jaws: 12-35 mm</li> </ul>
12-54 mm	Hilti	<ul style="list-style-type: none"> <li>NPR 032 IE-A22</li> </ul>	<ul style="list-style-type: none"> <li>NPR PR jaws: 12-35 mm</li> <li>NPR PR jaws: 42-54 mm</li> </ul>
12-108 mm, 63 mm	Hilti	<ul style="list-style-type: none"> <li>NPR 032 PE-A22</li> </ul>	<ul style="list-style-type: none"> <li>NPR-PS jaws: 12-35 mm</li> <li>NPR PR jaws with adapter 42-88,9 mm (with NPR PA3 adapter), 108 mm (with NPR PA3+NPR PA4 adapter)</li> </ul> <p><b>IMPORTANT:</b> press in two stages (108 mm)</p>
12-35 mm	Milwaukee	<ul style="list-style-type: none"> <li>M12 HPT-202C</li> </ul>	<ul style="list-style-type: none"> <li>J12 jaws: 12-35 mm</li> </ul>
12-54 mm	Milwaukee	<ul style="list-style-type: none"> <li>M18 HPT-202C</li> </ul>	<ul style="list-style-type: none"> <li>J18 jaws: 12-35 mm</li> <li>RJ jaws: 42-54 mm (with RJA adapter)</li> </ul>
12–35 mm	REMS	<ul style="list-style-type: none"> <li>Mini Press ACC (12V)</li> </ul>	<ul style="list-style-type: none"> <li>REMS Mini Press jaws: 12–35 mm*</li> </ul>
12–54 mm	REMS	<ul style="list-style-type: none"> <li>Powerpress 2000 (230 V)</li> <li>Powerpress E (230 V)</li> <li>Powerpress ACC (230 V)</li> <li>Accu-Press (12 V)</li> <li>Accu-Press ACC (12 V)</li> </ul>	<ul style="list-style-type: none"> <li>REMS jaws: 12–54 mm* (4G)</li> <li>Collars and adapter: 42–54 mm (PR3-S)</li> </ul>

Size	Manufacturer	Press type	Jaws/tongs
12–108 mm	REMS	■ Power-Press XL ACC	<ul style="list-style-type: none"> <li>■ REMS jaws: 12–35 mm (2G)</li> <li>■ REMS jaws: 42 mm (4G)</li> <li>■ Collars and adapter: 42 mm (PR-3S + Z2)</li> <li>■ REMS jaws: 54 mm (4G)</li> <li>■ Collars and adapter: 54 mm (PR-3S + Z2)</li> <li>■ Collars and adapter: XP66,7 mm (PR-3S + Z6 XL)</li> <li>■ Collars and adapter: 76,1–108 mm (PR-3S + Z6 XL)</li> </ul>
12–54 mm	Rothenberger	<ul style="list-style-type: none"> <li>■ Romax AC ECO</li> <li>■ Romax 3000 Akku</li> <li>■ Romax 3000 AC</li> <li>■ Romax 4000</li> </ul>	<ul style="list-style-type: none"> <li>■ KAN-therm jaws M12–35 mm</li> <li>■ KAN-therm collars M42–54 with adapter (ZBS1)</li> </ul>

\* only 18 and 28 mm forks marked as "108" (Q1 2008) or newer allowed

Utilization of other press tools requires consultation with the manufacturer of the installation system each time.



### Tools – work safety

**Before starting any works, make sure you read the instruction manual and learn the principles of safe work. All tools must be used according to their dedication and the manufacturer's instruction manual. During the use of tools, one must observe the terms of regular inspections and all applicable safety regulations. Using tools against their designed use may lead to their damage or to the damage of their accessories and pipes. It may also lead to the occurrence of leakages in installation joints.**

### KAN-therm tools:



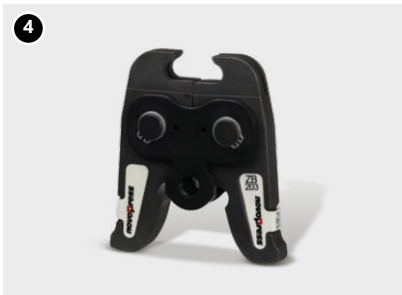
1. Electric press KAN-therm AC 3000
2. Battery-powered press KAN-therm DC 4000
3. KAN-therm M22–54 mm jaws
4. Collar jaw M42-54 mm
5. Adapter ZBS1 42-54 mm



**NOVOPRESS tools:**



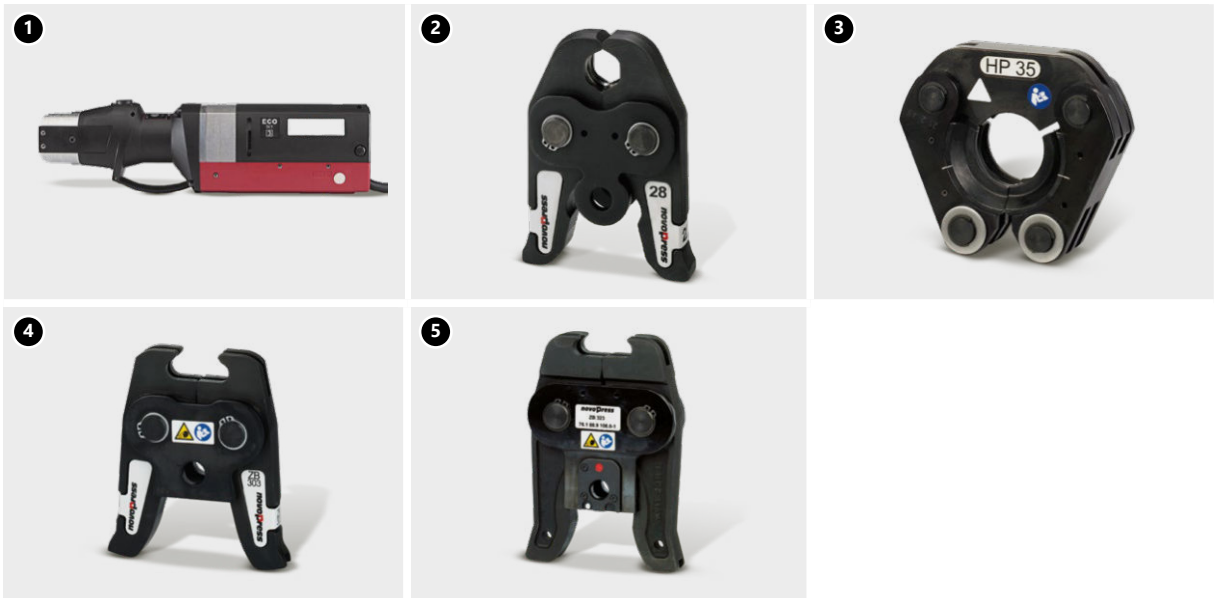
1. Battery-powered press ACO102
2. Battery-powered press ACO103
3. M15-35 mm jaw



1. Battery-powered press ACO203XL
2. PB2 M12-35 mm jaw
3. HP/M 35-108 Snap On press collar
4. ZB203 adapter
5. ZB221, ZB222 adapter



1. Electric press EFP203
2. PB2 M12-35 mm jaw
3. HP/M 35-54 Snap On press collar
4. ZB203 adapter



1. Electric press ECO 301\*
  2. PB3 M12-28 mm jaw
  3. HP/M 35-66,7 Snap On press collar
  4. ZB303 adapter
  5. ZB323 adapter
- \*Tool is not available in the KAN-therm system offer.



1. Battery-powered press ACO 401/ACO 403
2. HP 76,1-108 Snap On press collar
3. HP 139,7-168,3 mm press collar

**NOTE!**

**Novopress type HP jaws with diameters of 54-108 mm cannot be used with the Novopress ACO203XL press tool when using 1.4404 and 1.4521 stainless steel pipes. This tool configuration can only be used with 1.4401 stainless steel pipes available in the KAN-therm Inox Sprinkler system range.**

### REMS tools:



1. Electric press Power-Press ACC
2. Battery-powered press Akku-Press
3. Electric press Power-Press SE
4. M12–35 mm jaw
5. M42–54 mm jaw

### KLAUKE tools:



1. Battery-powered press KAN-therm Mini
2. SBM M 15–28 mm jaws



1. Battery-powered press UAP100\*
2. 76,1 – 108 mm jaws\*

\*The tools are not available in the KAN-therm system offer.

## Preparation of pipes for pressing



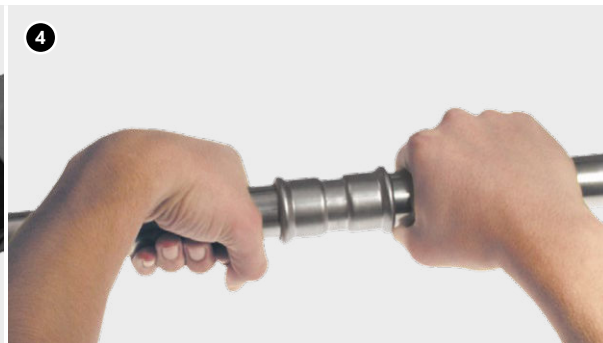
### 1. Cutting pipes

Cut pipes perpendicularly to the axis using a roll pipe cutter (breaking incompletely cut pipe sections is prohibited). You may also use other tools, such as hand saws and electric saws designed for cutting carbon or stainless steel, provided that the cut is made perpendicularly and the edges of the pipe are not chipped. Do not use torches or cutting discs for pipe cutting, which can generate significant amounts of heat, angle grinders, etc.



### 2. Chamfering

Use a manual chamfer (for diameters 76,1–168,3 – a semi-round steel file) to chamfer the internal and external edge of the pipe, removing all chips, which could potentially damage the O-Ring during assembly.



### 3. Inspection

Prior to assembly, visually inspect the presence and condition of the O-Ring. Check, if there are no chips or metal shavings or other pollutions on the pipe and the fitting, which could damage the seal during installation. Make sure if the distance between neighboring fittings is above the permissible ( $d_{min}$ ).

### 4. Mounting the pipe and the joint

To achieve the correct strength of a joint, ensure a proper depth A (tab. 1, fig. 1) of inserting the pipe into the fitting. Before pressing, insert the pipe into the fitting up to the marked depth (slight rotation permissible). Do not use lubricants, greases or fats when mounting the pipe (water or a soap solution is permissible – recommended for pressure tests conducted with compressed air).



### 5. Marking the depth of the mount

In order to ensure the correct durability of your joint, maintain proper depth A (table on page 121) of mount of the pipe inside the fitting. When mounting multiple joints at the same time (sliding pipes into fittings), before pressing next joints, inspect the pipe insertion depth. To do this, just check if the pipe is inserted into the fitting as far as possible.

To facilitate the identification of the pipe insertion depth in the fitting, use a simple technique of marking with a marker. It consists in sliding the pipe into the fitting as far as possible and then making a mark on the pipe, right next to the very edge of the fitting socket. After pressing, this mark must still be visible right at the edge of the fitting.

You can also use special patterns to mark the sliding depth without checking it with the fitting.

**Note: The patterns to mark the sliding depth are not part of the basic system offer and may be available depending on the markets where the product is sold.**



### 6. Pressing joints

Before starting any works, read all suitable instruction manuals and verify the proper operation of your tools. Use press tools and jaws recommended by KAN.

Select the size of your press jaw basing on the diameter of the joint. Place the jaws on the joint so that its notch embraces the protruding part of the fitting (the space where the O-Ring is located). After starting the press, the process takes place automatically and cannot be stopped. If, for any reason, the process of pressing is stopped, the joint needs to be disassembled (cut off) and a new one needs to be executed. If the installer has press tools and jaws not supplied by the KAN-therm, the possibility of using them should be consulted with KAN's Technical Department.



#### 7. Pressing 76,1–108 mm joints - preparing the jaws

To press the biggest diameters (76,1; 88,9; 108), use a special, four-part jaw (collar). After taking the jaws out of the box, unlock it. Next, open the jaws.

8. Mount the opened jaws on the fitting. The jaws are equipped with a special notch, which fits the collar on the fitting.

**Notice: A label with the size of the jaws (visible on the figure) should be always located at the side of the pipe.**

9. After the jaw is properly located on the fitting, it should be secured again by pressing the pin as far as possible (Klauke collars) or checking the alignment of the markers (Novopress collars). At this moment, the jaws are ready to be connected to the press machine.



#### 10. Connecting the press machine to the jaws

Connect the press tool to the collar. It is absolutely necessary to ensure that the press tool is connected to the collar in accordance with the instructions attached to the specific tool.

A press machine connected this way may be started for the purpose of executing a fully pressed joint.

#### 11. Pressing

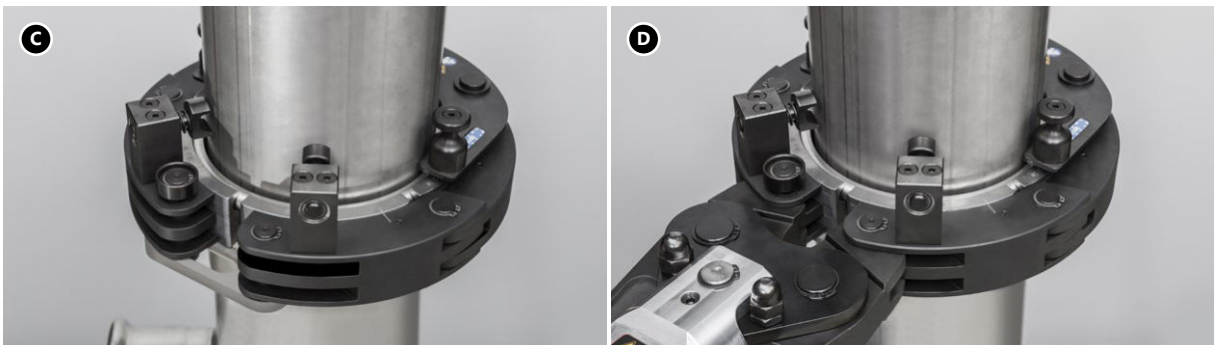
The full time of executing one pressed joint is c.a. 1 min. (applies to diameters: 76,1–108 mm). After starting the press, the process takes place automatically and cannot be stopped. If, for any reason, the process of pressing is stopped, the joint needs to be disassembled (cut off) and a new one needs to be executed. After executing the pressed joint, the press machine will automatically return to its primary position. After that, remove the arms of the press machine from the jaws. To remove the collar from the fitting, unlock it again and then unfold it. Klauke collars should be stored in the suitcases in a secured condition - locked.

## Placing 139,7 - 168,3 collars on the fitting

For GigaSize diameters 139,7 – 168,3 in order to unfold the collar, press the pin shown in the photo (A), and then unfasten the connector (B).



Mount the opened collar on the fitting. The collars are equipped with a special notch, which fits the protrusion on the fitting. After mounting the collar on the fitting, lock them again by reinstalling the connector and locking the pin.



Connect the press tool to the collar. It is absolutely necessary to ensure that the press tool is connected to the collar in accordance with the instructions attached to the specific tool. The press tool connected to the collar can be started in order to fully press the first stage of the connection. After starting the press, the process takes place automatically and cannot be stopped. If, for any reason, the process of pressing is stopped, the joint needs to be disassembled (cut off) and a new one needs to be executed. After executing the pressed joint, the press machine will automatically return to its primary position. After that, remove the arms of the press machine from the collar.



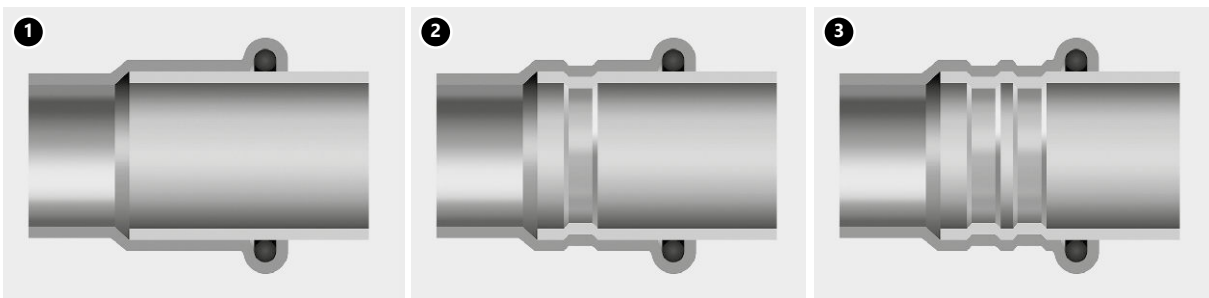
Before performing the second stage of making the connection, the collar should be disassembled and then placed with rollers and spring pins in the place where the sealing O-Ring is installed. After the collar is properly mounted on the fitting, it should be secured again by pressing the pin and fastening the connector. Reconnect the press tool to the collar.

It is absolutely necessary to ensure that the press tool is connected to the collar in accordance with the instructions attached to the specific tool. The press tool connected to the collar can be started in order to fully press the second stage of the connection. The rules given at the first stage of the connection should be followed. After executing the pressed joint, the press machine will automatically return to its primary position. After that, remove the arms of the press machine from the collar.

Correctly made two-stage press connection with a diameter of 139,7 and 168,3 mm is characterized by a double ring imprinted on the fitting, as shown in the photo below:



Before each start of works and at intervals defined by the manufacturer, the tools should be checked and lubricated.

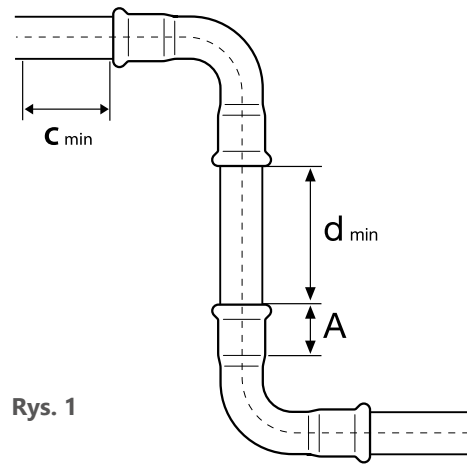


Press connection before (1) and after press (2, 3)  
2. diameter range 12–108 mm  
3. diameter range 139,7 and 168,3 mm



## Pipe insertion depth in the fitting and minimum distance between pressed fittings

Ø [mm]	A [mm]	d <sub>min</sub> [mm]	C <sub>min</sub> [mm]
12	17	10	40
15	20	10	40
18	20	10	40
22	21	10	40
28	23	10	60
35	26	10	70
42	30	20	70
54	35	20	70
66,7	50	30	80
76,1	55	55	80
88,9	63	65	90
108	77	80	100
139,7	100	60	-
168,3	121	60	-



Rys. 1

- A – Pipe insertion depth in the fitting,
- d<sub>min</sub> – minimum distance between fittings allowing press correctness
- C<sub>min</sub> – minimal distance of fitting from wall

## Minimal assembly distances

Ø [mm]	Fig. 1		Fig. 2		
	a [mm]	b [mm]	a [mm]	b [mm]	c [mm]
12/15	56	20	75	25	28
18	60	20	75	25	28
22	65	25	80	31	35
28	75	25	80	31	35
35	75	30	80	31	44
42	140/115*	60/75*	140/115*	60/75*	75
54	140/120*	60/85*	140/120*	60/85*	85
76	140*	110*	165*	115*	115
88	150*	120*	185*	125*	125
108	170*	140*	200*	135*	135
139	290*	230*	290*	230*	230*
168	330*	260*	330*	260*	260*

\*applies to four-part pressing jaws

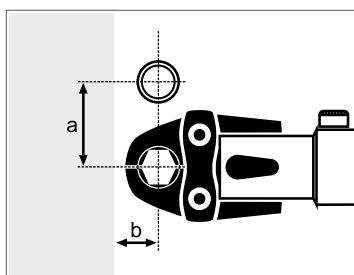


Fig. 1

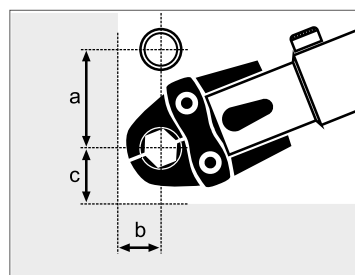


Fig. 2

## Pipe bending

If there is a need, KAN-therm Inox pipes may be bent "cold", provided that the minimal bending radius  $R_{\min}$  is observed:

$$R_{\min} = 3,5 \times D_e$$

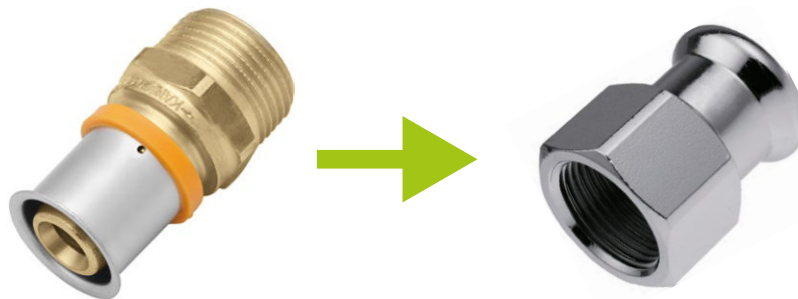
$D_e$  – external diameter of the pipe

Do not bend the pipes "hot", due to the vulnerability of pipes processed this way to corrosion resulting from a change in the crystal structure of their material.

Use manual benders to bend the pipe. These may be electric or hydraulic. Do not "cold" bend pipes with diameters exceeding  $\varnothing 28$  mm (use ready-made bends and elbows  $90^\circ$  and  $45^\circ$  supplied as part of the KAN-therm system).

Do not weld or solder KAN-therm Inox pipes, since this process changes the structure of material, which might lead to corrosion.

## Threaded fittings, connecting with other KAN-therm systems



The principle of connecting KAN-therm Inox joints with brass fittings

KAN-therm Inox system offer a wide selection of fittings with male and female threads. Since fittings with male threads are equipped with cone threads (pipe), in threaded joints with brass shape fittings, you can only use male threads for brass joints, sealed with e.g. a small amount of tow. It is suggested that the threaded (screwed) joint is executed before pressing the joint, so that no additional load is applied on the pressed joint. Do not use standard PTFE tape or any other solutions containing halides (e.g. chlorides) to seal threads in KAN-therm Inox installations.

Threaded fittings with other fixtures and threaded elements outside the system KAN-therm offer should be made in line with EN 10226 (ISO 7-1) and EN ISO 228 depending on the thread type.

## 3.6 Flange connections



Table of Inox flange connections

Code	Size	Amount of screws/nuts	Screw size	Screw class	Nut class	Amount of washers	Flange	Flat seal
1609091004	15 DN15 PN16	4	M12	8.8	8	8	DN15	DN12 EPDM
1609091005	18 DN15 PN16	4	M12	8.8	8	8	DN15	DN15 EPDM
1609091006	22 DN20 PN16	4	M12	8.8	8	8	DN20	DN20 EPDM
1609091007	28 DN25 PN16	4	M12	8.8	8	8	DN25	DN25 EPDM
1609091001	35 DN32 PN16	4	M16	8.8	8	8	DN32	DN32 EPDM
1609091008	42 DN40 PN16	4	M16	8.8	8	8	DN40	DN40 EPDM
1609091009	54 DN50 PN16	4	M16	8.8	8	8	DN50	DN50 EPDM
1609091002	76,1 DN65 PN16	4	M16	8.8	8	8	DN65	DN65 EPDM
1609091003	88,9 DN80 PN16	8	M16	8.8	8	16	DN80	DN80 EPDM
1609091000	108 DN100 PN16	8	M16	8.8	8	16	DN100	DN100 EPDM
1609091010	139,7 DN125 PN16	8	M18	8.8	8	16	DN125	DN125 EPDM
1609091011	168,3 DN150 PN16	8	M20	8.8	8	16	DN150	DN150 EPDM

### 3.7 Ball valves of KAN-therm Inox system



Ball valves are intended for direct assembly on KAN-therm system pipelines using the radial pressing technique in profile "M". There are available versions with stub pipes pressed on both sides or pressed-on stub pipes and half union with flat sealing. The working pressure of 16 bar at working temperatures of -35 to +135 °C (150 °C short-term). The valves make it possible to shut off a part of an installation. When fully open, the valve has a minimum pressure drop. The valves are covered with a 5-year manufacturer's warranty.

Installation system	KAN-therm Inox system
<b>Construction materials</b>	<ul style="list-style-type: none"> <li>■ body – stainless steel 1.4404,</li> <li>■ ball – stainless steel 1.4401,</li> <li>■ spindle and socket – stainless steel 1.4401,</li> <li>■ lever – nylon reinforced with fibre PA66,</li> <li>■ pipe stub sealing – EPDM70,</li> <li>■ ball sealing – PTFE.</li> </ul>
<b>Operating pressure</b>	16 bar
<b>Operating temperature</b>	-35 ÷ 135 °C
<b>Maximal temperature</b>	150 °C
<b>Crimping profile</b>	M
<b>Colour</b>	silver, black lever
<b>Marking</b>	System KAN-therm Manufactured in Denmark by BROEN
<b>Certification</b>	ITB KOT

KAN-therm Inox ball valves can be used in compressed air installations with the following requirements:  
 — the maximum oil content of 5 mg/m<sup>3</sup> is not exceeded -class 4 acc. to ISO 8573-1.



**KAN-therm Inox valves are not allowed to transport compressed air which contains mineral oils.**

## Service and maintenance

The valves do not need extra service under normal conditions, but to guarantee the good working of the valves, opening and closing the valve regularly is highly recommended, depending on medium and use. The table below can be used as a guideline in relation to operation and maintenance.

Medium	Function testing interval
Domestic hot water	Twice annually
Domestic hot water (calcareous)	4-6 times annually
Heating	Twice annually
Cooling	Twice annually
Compressed air	Once annually

### 3.8 Operational notes

#### Equipotential bonding

Every finished metal installation has to be provided with connections equalizing electrical potentials, i.e. grounded in order to prevent stray currents and occurrence of contact corrosion.

According to regulations in force, the connections of grounding conductors have to be made by welding or by threaded clamps and the connections to the pipelines must be made with screw clamps. In order to make the correct equipotential bonding, it is necessary to:

1. Get information on the applied electric shock protection solution (grounding method) in the building object.
2. Connect the equalizing conduit to the pipe with the appropriate clamp. In order to eliminate the risk of contact corrosion, the clamp must be selected according to the type of pipe.
3. Make the serial connections of all individual pipelines branches with a use of potentials equalization conduits and connect them to the main grounding collecting bar of the building object.

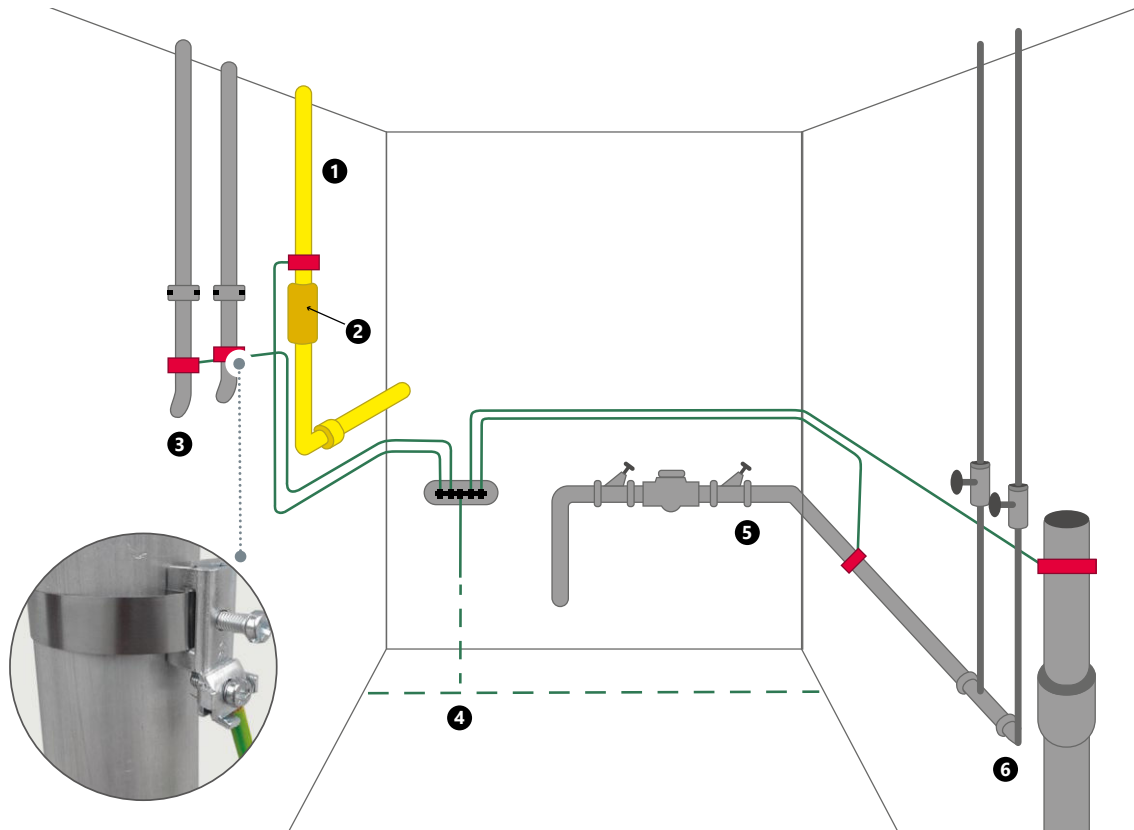


#### **Attention!**

**Remove the insulation, paintwork and dirt from the pipe in clamp assembly places.**

The length of the electrical conduits from the piping system to the grounding collecting bar of the potential equalization system should be as short as possible.

Calculations of the electrical potentials equalization system in the building object must be performed by person with appropriate qualifications.



1. Gas
2. Insulation liner
3. Central heating
4. Foundation grounding
5. Water
6. Sewer

### 3.9 Transport and storage

- Elements of the KAN-therm Inox must be stored separately from other metal elements such as carbon steel.
- Do not store elements of the system directly on the ground (e.g. on soil or concrete).
- Do not store elements of the system in the vicinity of chemical solutions.
- Pipe bundles should be stored and transported on wooden pallets (avoid direct contact with other steel elements, e.g. pipe stands).
- During transport, loading and unloading, be extra careful not to scratch or damage the pipes or fittings – do not: throw, drag or bend them.
- Rooms designed for storing elements of the system must be dry.
- During their storage, assembly and use, pipe surfaces must not be exposed to long-term, direct contact with water or humidity.



Detailed information about storage and transport of components can be found at [en.kan-therm.com](http://en.kan-therm.com).

# SYSTEM KAN-therm Inox - assortment

## Pipes

### Stainless steel pipe 1.4404 - bar

GROUP: H

Size [mm]	*	Code			UM
12x1,0	***	1629194065	6	1014	m
15x1,0		1629194001	6	762	m
18x1,0		1629194002	6	366	m
22x1,2		1629194003	6	366	m
28x1,2		1629194004	6	222	m
35x1,5		1629194005	6	222	m
42x1,5		1629194006	6	114	m
54x1,5		1629194007	6	114	m
76,1x2,0		1629194008	6	144	m
88,9x2,0		1629194009	6	96	m
108x2,0		1629194000	6	78	m
139,7x2,0	**	1629194035	6	60	m
168,3x2,0	**	1629194036	6	54	m



### Stainless steel pipe 1.4521 - bar

GROUP: H

Size [mm]	*	Code			UM
15x1,0		1629194021	6	762	m
18x1,0		1629194023	6	396	m
22x1,2		1629194025	6	366	m
28x1,2		1629194027	6	222	m
35x1,5		1629194029	6	222	m
42x1,5		1629194031	6	114	m
54x1,5		1629194033	6	114	m
76,1x2,0		1629194066	6	144	m
88,9x2,0		1629194067	6	96	m
108x2,0		1629194068	6	78	m



 coil 
  bar 
  pipes in tube 
  bag 
  carton box 
  pallet 
  new 
  available soon

\* custom-made - lead time max 4 weeks | \*\* availability as agreed | \*\*\* while stock lasts

## Connectors



### Female connector



GROUP: G

Size [mm]	*	Code			UM
12 Rp $\frac{3}{8}$ "	***	1609042026	10	50	pc.
12 Rp $\frac{1}{2}$ "	***	1609042025	10	50	pc.
15 Rp $\frac{1}{2}$ "		1609042000	10	130	pc.
15 Rp $\frac{3}{4}$ "		1609042001	10	90	pc.
18 Rp $\frac{1}{2}$ "		1609042002	10	120	pc.
18 Rp $\frac{3}{4}$ "		1609042003	10	80	pc.
22 Rp $\frac{1}{2}$ "		1609042005	10	100	pc.
22 Rp $\frac{3}{4}$ "		1609042006	10	100	pc.
22 Rp1"		1609042004	10	60	pc.
28 Rp $\frac{1}{2}$ "		1609042027	10	40	pc.
28 Rp $\frac{3}{4}$ "		1609042009	10	40	pc.
28 Rp1"		1609042007	10	60	pc.
28 Rp1 $\frac{1}{4}$ "		1609042008	10	30	pc.
35 Rp1"		1609042012	10	20	pc.
35 Rp1 $\frac{1}{4}$ "		1609042011	10	30	pc.
35 Rp1 $\frac{1}{2}$ "		1609042010	10	20	pc.
42 Rp1 $\frac{1}{4}$ "		1609042014	4	12	pc.
42 Rp1 $\frac{1}{2}$ "		1609042013	4	24	pc.
54 Rp1 $\frac{1}{2}$ "		1609042015	1	12	pc.
54 Rp2"		1609042016	4	12	pc.



### Male connector

GROUP: G

Size [mm]	*	Code			UM
12 R $\frac{3}{8}$ "	***	1609045042	10	50	pc.
12 R $\frac{1}{2}$ "	***	1609045041	10	50	pc.
15 R $\frac{1}{2}$ "		1609045004	10	200	pc.
15 R $\frac{3}{4}$ "		1609045005	10	80	pc.
18 R $\frac{1}{2}$ "		1609045006	10	160	pc.
18 R $\frac{3}{4}$ "		1609045007	10	100	pc.
22 R $\frac{1}{2}$ "		1609045009	10	70	pc.
22 R $\frac{3}{4}$ "		1609045010	10	100	pc.
22 R1"		1609045008	10	60	pc.
28 R $\frac{3}{4}$ "		1609045013	10	50	pc.
28 R1"		1609045012	10	60	pc.
28 R1 $\frac{1}{4}$ "		1609045011	10	30	pc.
35 R1"		1609045015	10	40	pc.
35 R1 $\frac{1}{4}$ "		1609045016	5	40	pc.
35 R1 $\frac{1}{2}$ "		1609045014	10	20	pc.
42 R1 $\frac{1}{4}$ "		1609045018	4	12	pc.
42 R1 $\frac{1}{2}$ "		1609045017	4	24	pc.
54 R1 $\frac{1}{2}$ "		1609045019	4	16	pc.
54 R2"		1609045020	4	12	pc.
76,1 R2 $\frac{1}{2}$ "		1609045002	2	20	pc.
88,9 R3"		1609045003	-	2	pc.

 coil  bar  pipes in tube  bag  carton box  pallet **N** new  available soon

\* custom-made - lead time max 4 weeks | \*\* availability as agreed | \*\*\* while stock lasts



## Coupling Inox/Groove



GROUP: G

Size [mm]	*	Code			UM
28 / 33,7		1609042030	10	30	pc.
35 / 42,4		1609042031	10	30	pc.
42 / 48,3		1609042032	5	20	pc.
54 / 60,3		1609042033	5	15	pc.
76,1		1609042034	1	30	pc.
88,9		1609042035	2	30	pc.
108 / 114		1609042028	1	10	pc.



## Female slip connector

GROUP: G

Size [mm]	*	Code			UM
22 Rp $\frac{1}{2}$ "		1609042037	10	60	pc.
22 Rp $\frac{3}{4}$ "		1609042038	10	60	pc.
28 Rp $\frac{1}{2}$ "		1609042039	10	40	pc.
28 Rp $\frac{3}{4}$ "		1609042040	10	40	pc.



## Female union

GROUP: G

Size [mm]	*	Code			UM
15 Rp $\frac{1}{2}$ "		1609271000	2	60	pc.
15 Rp $\frac{3}{4}$ "		1609271001	2	40	pc.
18 Rp $\frac{1}{2}$ "		1609271002	2	40	pc.
18 Rp $\frac{3}{4}$ "		1609271003	2	40	pc.
22 Rp $\frac{3}{4}$ "		1609271010	2	40	pc.
22 Rp1"		1609271004	2	30	pc.
28 R1"		1609271011	2	26	pc.
35 R1 $\frac{1}{4}$ "		1609271012	1	20	pc.
42 R1 $\frac{1}{2}$ "		1609271013	2	8	pc.
54 Rp2"		1609271009	2	4	pc.



## Male union

GROUP: G

Size [mm]	*	Code			UM
15 R $\frac{1}{2}$ "		1609272000	2	50	pc.
15 R $\frac{3}{4}$ "		1609272011	2	60	pc.
18 R $\frac{1}{2}$ "		1609272012	2	60	pc.
18 R $\frac{3}{4}$ "		1609272003	2	60	pc.
22 R $\frac{1}{2}$ "		1609272005	2	40	pc.
22 R $\frac{3}{4}$ "		1609272013	2	40	pc.
22 R1"		1609272004	2	30	pc.
28 R1"		1609272014	2	30	pc.
35 R1 $\frac{1}{4}$ "		1609272015	2	16	pc.
42 R1 $\frac{1}{2}$ "		1609272009	2	12	pc.
54 R2"		1609272016	2	4	pc.



 coil 
  bar 
  pipes in tube 
  bag 
  carton box 
  pallet 
  new 
  available soon

\* custom-made - lead time max 4 weeks | \*\* availability as agreed | \*\*\* while stock lasts



### Union

GROUP: G

Size [mm]	*	Code			UM
15		1609271021	2	50	pc.
18		1609271022	2	60	pc.
22		1609271023	2	40	pc.
28		1609271024	2	30	pc.
35		1609271025	1	16	pc.
42		1609271026	2	12	pc.
54		1609271027	2	4	pc.



### Female half union with flat sealing

GROUP: G

Size [mm]	*	Code			UM
15 G $\frac{3}{4}$ "		1609271014	10	120	pc.
18 G $\frac{3}{4}$ "		1609271015	10	100	pc.
22 G1"		1609271016	10	60	pc.
28 G1 $\frac{1}{4}$ "		1609271017	10	40	pc.
35 G1 $\frac{1}{2}$ "		1609271018	4	32	pc.
42 G1 $\frac{1}{4}$ "		1609271019	4	12	pc.
54 G2 $\frac{3}{8}$ "		1609271020	4	8	pc.



### Straight coupling

GROUP: G

Size [mm]	*	Code			UM
12	***	1609245002	10	70	pc.
15		1609245003	10	140	pc.
18		1609245004	10	140	pc.
22		1609245012	10	80	pc.
28		1609245013	10	60	pc.
35		1609245014	5	40	pc.
42		1609245015	4	24	pc.
54		1609245016	4	16	pc.
76,1		1609245010	4	24	pc.
88,9		1609245011	4	8	pc.
108		1609245000	2	10	pc.
139,7	**	1609245017	1	1	pc.
168,3	**	1609245018	1	1	pc.



### Slip coupling

GROUP: G

Size [mm]	*	Code			UM
15		1609080001	10	140	pc.
18		1609080002	10	100	pc.
22		1609080003	10	60	pc.
28		1609080004	10	40	pc.
35		1609080005	5	20	pc.
42		1609080010	4	16	pc.
54		1609080007	2	8	pc.
76,1		1609080008	2	6	pc.
88,9		1609080009	2	10	pc.
108		1609080000	2	4	pc.

coil 
 bar 
 pipes in tube 
 bag 
 carton box 
 pallet 
 new 
 available soon

\* custom-made - lead time max 4 weeks | \*\* availability as agreed | \*\*\* while stock lasts

## Elbow 90°

GROUP: G

Size [mm]	*	Code			UM
12	***	1609068149	10	70	pc.
15		1609068150	10	150	pc.
18		1609068151	10	90	pc.
22		1609068152	10	60	pc.
28		1609068115	5	30	pc.
35		1609068153	5	20	pc.
42		1609068154	2	8	pc.
54		1609068155	2	8	pc.
76,1		1609068125	2	10	pc.
88,9		1609068128	2	8	pc.
108		1609068107	2	4	pc.
139,7	**	1609068156	1	1	pc.
168,3	**	1609068157	1	1	pc.



## Plain end elbow 90°

GROUP: G

Size [mm]	*	Code			UM
15		1609068143	10	120	pc.
18		1609068144	10	60	pc.
22		1609068133	5	60	pc.
28		1609068145	5	30	pc.
35		1609068146	5	10	pc.
42		1609068147	2	8	pc.
54		1609068148	2	6	pc.
76,1		1609068139	2	10	pc.
88,9		1609068141	1	8	pc.
108		1609068130	2	4	pc.
<b>N</b> 139,7	*	1609068194	-	1	pc.
<b>N</b> 168,3	*	1609068195	-	1	pc.



## Elbow 45°

GROUP: G

Size [mm]	*	Code			UM
15		1609068079	10	150	pc.
18		1609068080	10	120	pc.
22		1609068051	10	70	pc.
28		1609068052	10	40	pc.
35		1609068081	5	25	pc.
42		1609068082	2	16	pc.
54		1609068083	2	8	pc.
76,1		1609068057	-	2	pc.
88,9		1609068059	2	8	pc.
108		1609068048	2	6	pc.
139,7	**	1609068084	-	1	pc.
168,3	**	1609068085	1	1	pc.



 coil 
  bar 
  pipes in tube 
  bag 
  carton box 
  pallet 
 **N** new 
  available soon

\* custom-made - lead time max 4 weeks | \*\* availability as agreed | \*\*\* while stock lasts



### Plain end elbow 45°

GROUP: G

Size [mm]	*	Code			UM
15		1609068073	10	150	pc.
18		1609068074	10	120	pc.
22		1609068075	10	60	pc.
28		1609068076	10	40	pc.
35		1609068066	5	25	pc.
42		1609068077	4	16	pc.
54		1609068078	2	8	pc.
76,1		1609068070	2	12	pc.
88,9		1609068072	-	2	pc.
108		1609068061	2	4	pc.
<b>N</b> 139,7	*	1609068192	-	1	pc.
<b>N</b> 168,3	*	1609068193	-	1	pc.



### Tee



GROUP: G

Size [mm]	*	Code			UM
12	***	1609257045	10	60	pc.
15		1609257002	10	80	pc.
18		1609257046	10	40	pc.
22		1609257005	10	40	pc.
28		1609257047	5	25	pc.
35		1609257048	5	15	pc.
42		1609257049	4	8	pc.
54		1609257050	2	6	pc.
76,1		1609257010	2	8	pc.
88,9		1609257011	2	6	pc.
108		1609257000	2	2	pc.
139,7	**	1609257001	-	1	pc.
168,3	**	1609257003	-	1	pc.

## Reducing tee

## GROUP: G



Size [mm]	*	Code			UM
18 / 15 / 18		1609260014	10	60	pc.
22 / 15 / 22		1609260046	10	50	pc.
22 / 18 / 22		1609260047	10	50	pc.
28 / 15 / 28		1609260048	5	30	pc.
28 / 18 / 28		1609260049	10	30	pc.
28 / 22 / 28		1609260050	5	30	pc.
35 / 15 / 35		1609260020	5	20	pc.
35 / 18 / 35		1609260021	5	20	pc.
35 / 22 / 35		1609260022	5	20	pc.
35 / 28 / 35		1609260051	5	20	pc.
42 / 22 / 42		1609260024	4	12	pc.
42 / 28 / 42		1609260052	4	12	pc.
42 / 35 / 42		1609260053	4	12	pc.
54 / 22 / 54		1609260054	2	8	pc.
54 / 28 / 54		1609260030	2	8	pc.
54 / 35 / 54		1609260055	2	8	pc.
54 / 42 / 54		1609260032	2	8	pc.
76,1 / 22 / 76,1		1609260035	2	12	pc.
76,1 / 28 / 76,1		1609260036	-	2	pc.
76,1 / 35 / 76,1		1609260037	2	10	pc.
76,1 / 42 / 76,1		1609260038	2	12	pc.
76,1 / 54 / 76,1		1609260039	1	4	pc.
88,9 / 22 / 88,9		1609260040	2	10	pc.
88,9 / 28 / 88,9		1609260041	-	2	pc.
88,9 / 35 / 88,9		1609260042	-	2	pc.
88,9 / 42 / 88,9		1609260043	2	8	pc.
88,9 / 54 / 88,9		1609260044	-	2	pc.
88,9 / 76,1 / 88,9		1609260045	2	2	pc.
108 / 22 / 108		1609260000	-	2	pc.
108 / 28 / 108		1609260001	2	6	pc.
108 / 35 / 108		1609260002	2	6	pc.
108 / 42 / 108		1609260003	-	2	pc.
108 / 54 / 108		1609260004	-	2	pc.
108 / 76,1 / 108		1609260005	-	2	pc.
108 / 88,9 / 108		1609260006	1	2	pc.
139,7 / 76,1 / 139,7	**	1609260008	1	1	pc.
139,7 / 88,9 / 139,7	**	1609260009	1	1	pc.
139,7 / 108 / 139,7	**	1609260007	1	1	pc.
168,3 / 76,1 / 168,3	**	1609260012	1	1	pc.
168,3 / 88,9 / 168,3	**	1609260013	1	1	pc.
168,3 / 108 / 168,3	**	1609260010	1	1	pc.
168,3 / 139,7 / 168,3	**	1609260011	1	1	pc.



 coil 
  bar 
  pipes in tube 
  bag 
  carton box 
  pallet 
  new 
  available soon

\* custom-made - lead time max 4 weeks | \*\* availability as agreed | \*\*\* while stock lasts



## Plain end reducer

GROUP: G

Size [mm]	*	Code			UM
15 / 12	***	1609220000	10	200	pc.
18 / 15		1609221003	10	200	pc.
22 / 15		1609221023	10	140	pc.
22 / 18		1609221024	10	120	pc.
28 / 15		1609221025	10	70	pc.
28 / 18		1609221007	10	100	pc.
28 / 22		1609221026	10	80	pc.
35 / 15		1609221027	5	50	pc.
35 / 18		1609221028	5	50	pc.
35 / 22		1609221029	5	50	pc.
35 / 28		1609221030	5	60	pc.
42 / 15		1609221031	5	30	pc.
42 / 18		1609221032	5	30	pc.
42 / 22		1609221033	4	24	pc.
42 / 28		1609221034	4	24	pc.
42 / 35		1609221035	4	24	pc.
54 / 15		1609221036	4	16	pc.
54 / 18		1609221037	4	16	pc.
54 / 22		1609221015	4	16	pc.
54 / 28		1609221016	4	16	pc.
54 / 35		1609221038	4	16	pc.
54 / 42		1609221039	4	16	pc.
76,1 / 42		1609221019	1	12	pc.
76,1 / 54		1609221020	4	32	pc.
88,9 / 54		1609221021	4	24	pc.
88,9 / 76,1		1609221022	4	12	pc.
108 / 54		1609221000	2	2	pc.
108 / 76,1		1609221001	2	2	pc.
108 / 88,9		1609221002	2	10	pc.
139,7 / 88,9	**	1609221041	-	1	pc.
139,7 / 108	**	1609221040	1	1	pc.
168,3 / 88,9	**	1609221044	1	1	pc.
168,3 / 108	**	1609221042	1	1	pc.
168,3 / 139,7	**	1609221043	-	1	pc.



## Female elbow 90°

GROUP: G

Size [mm]	*	Code			UM
15 Rp½"		1609068000	10	80	pc.
18 Rp½"		1609068001	10	90	pc.
22 Rp½"		1609068003	10	50	pc.
22 Rp¾"		1609068002	10	50	pc.
28 Rp½"		1609068009	5	30	pc.
28 Rp¾"		1609068005	5	30	pc.
28 Rp1"		1609068008	10	30	pc.
35 Rp½"		1609068011	5	10	pc.
35 Rp¾"		1609068007	5	10	pc.
35 Rp1"		1609068010	5	10	pc.
35 Rp1¼"		1609068012	5	10	pc.

 coil 
  bar 
  pipes in tube 
  bag 
  carton box 
  pallet 
  new 
  available soon

\* custom-made - lead time max 4 weeks | \*\* availability as agreed | \*\*\* while stock lasts

## Female elbow 90° with plain end

GROUP: G

Size [mm]	*	Code			UM
15 Rp½"		1609068013	10	40	pc.



## Male elbow 90°



GROUP: G

Size [mm]	*	Code			UM
15 R½"		1609070000	10	80	pc.
18 R½"		1609070002	10	80	pc.
22 R¾"		1609070004	10	60	pc.
28 R1"		1609070005	10	30	pc.
35 R1¼"		1609070006	5	20	pc.
42 R1½"		1609070009	2	16	pc.
54 R2"		1609070010	2	8	pc.

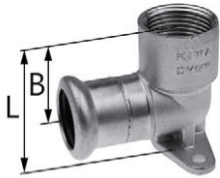


## Female tee

GROUP: G

Size [mm]	*	Code			UM
15 Rp½"		1609257014	10	70	pc.
18 Rp½"		1609257015	10	50	pc.
18 Rp¾"		1609257016	10	50	pc.
22 Rp½"		1609257017	10	40	pc.
22 Rp¾"		1609257018	10	40	pc.
28 Rp½"		1609257038	5	30	pc.
28 Rp¾"		1609257039	10	30	pc.
28 Rp1"		1609257019	5	30	pc.
35 Rp½"		1609257040	5	20	pc.
35 Rp¾"		1609257041	5	20	pc.
35 Rp1"		1609257022	5	20	pc.
42 Rp½"		1609257027	4	16	pc.
42 Rp¾"		1609257042	4	12	pc.
42 Rp1"		1609257026	4	12	pc.
54 Rp½"		1609257031	2	8	pc.
54 Rp¾"		1609257044	2	8	pc.
54 Rp1"		1609257030	2	8	pc.
54 Rp2"		1609257043	2	6	pc.
76,1 Rp¾"		1609257035	2	12	pc.
76,1 Rp2"		1609257034	2	10	pc.
88,9 Rp¾"		1609257037	2	8	pc.
88,9 R2"		1609257036	-	2	pc.
108 Rp¾"		1609257013	2	6	pc.
108 Rp2"		1609257012	2	6	pc.
<b>N</b> 139,7 Rp¾"	*	1609257063	-	1	pc.
<b>N</b> 139,7 Rp2"	*	1609257064	-	1	pc.



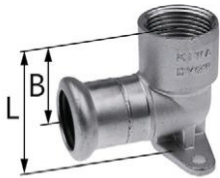


### Female directly fixed wallplate elbow - L = 41 mm

GROUP: G

Size [mm]	*	Code							UM
15 Rp $\frac{1}{2}$ "		1609285009					10	90	pc.

**Note:**  
B = 28 mm.

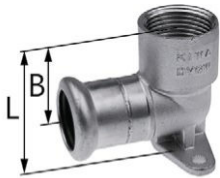


### Female directly fixed wallplate elbow - L = 44 mm

GROUP: G

Size [mm]	*	Code							UM
18 Rp $\frac{1}{2}$ "		1609285002					10	80	pc.

**Note:**  
B = 28 mm.



### Female directly fixed wallplate elbow - L = 52 mm

GROUP: G

Size [mm]	*	Code							UM
22 Rp $\frac{3}{4}$ "		1609285003					10	50	pc.

**Note:**  
B = 33 mm.



### Female directly fixed wallplate elbow - L = 63 mm

GROUP: G

Size [mm]	*	Code							UM
15 Rp $\frac{1}{2}$ "		1609285004					20	40	pc.
18 Rp $\frac{1}{2}$ "		1609285007					20	40	pc.

**Note:**  
Size B = 28 mm.



### Female directly fixed wallplate elbow - L = 64 mm

GROUP: G

Size [mm]	*	Code							UM
22 Rp $\frac{3}{4}$ "		1609285008					10	40	pc.

**Note:**  
Size B = 33 mm.



## Axial compensator

GROUP: G

	Size [mm]	*	Code			UM
N	15		1609037002	10	60	pc.
N	18		1609037004	10	60	pc.
N	22		1609037005	5	30	pc.
N	28		1609037007	4	20	pc.
N	35		1609037008	4	16	pc.
N	42		1609037010	2	6	pc.
N	54		1609037011	1	4	pc.



**Note:**

The warranty is provided for 1000 cycles of operation when used as intended.  
The axial compensator is suitable only for absorbing axial movements of the pipeline.



## Axial compensator

GROUP: G

	Size [mm]	*	Code			UM
N	76,1		1609037013	2	8	pc.
N	88,9		1609037014	2	4	pc.
N	108		1609037000	2	6	pc.



**Note:**

The warranty is provided for 1000 cycles of operation when used as intended.  
The axial compensator is suitable only for absorbing axial movements of the pipeline.



## Crossover



GROUP: G

	Size [mm]	*	Code			UM
	15		1609178000	10	80	pc.
	18		1609178001	10	50	pc.
	22		1609178002	10	50	pc.
	28		1609178003	10	20	pc.



## Bend 15°

GROUP: G

	Size [mm]	*	Code			UM
	28		1609011002	10	40	pc.
	35		1609011003	5	15	pc.
	42		1609011004	2	20	pc.
	54		1609011005	1	6	pc.



## Bend 30°

GROUP: G

	Size [mm]	*	Code			UM
	28		1609011009	10	40	pc.
	35		1609011008	4	12	pc.
	42		1609011010	2	20	pc.
	54		1609011011	1	8	pc.





### Bend 60°

GROUP: G

Size [mm]	*	Code			UM
28		1609011014	5	30	pc.
35		1609011015	4	12	pc.
42		1609011016	5	20	pc.
54		1609011017	2	6	pc.



### Bend 90°

GROUP: G

Size [mm]	*	Code			UM
15		1609011018	10	70	pc.
18		1609011019	10	50	pc.
22		1609011025	2	4	pc.
28		1609011026	5	20	pc.
35		1609011027	4	8	pc.
42		1609011028	2	4	pc.
54		1609011029	2	10	pc.



### Stop end

GROUP: G

Size [mm]	*	Code			UM
15		1609250002	20	80	pc.
18		1609250004	20	300	pc.
22		1609250006	10	150	pc.
28		1609250020	10	130	pc.
35		1609250010	5	75	pc.
42		1609250012	4	48	pc.
54		1609250021	1	24	pc.
76,1		1609250016	2	4	pc.
88,9		1609250018	2	4	pc.
108		1609250000	2	4	pc.



### Ball valve

GROUP: G

Size [mm]	*	Code			UM
N 15		1609278000	1	25	pc.
N 18		1609278001	1	25	pc.
N 22		1609278002	1	15	pc.
N 28		1609278003	1	10	pc.
N 35		1609278004	1	10	pc.
N 42		1609278005	1	7	pc.
N 54		1609278006	1	5	pc.

The ball is made of stainless steel 1.4401.  
Max working pressure 16 bar  
Warranty for 5 years.

## Ball valve with female half union with flat sealing

GROUP: G

Size [mm]	*	Code			UM
N 15 G¾"		1609278007	1	25	pc.
N 18 G¾"		1609278008	1	25	pc.
N 22 G¾"		1609278009	1	15	pc.
N 28 G1¼"		1609278010	1	10	pc.
N 35 G1½"		1609278011	1	10	pc.
N 42 G1¾"		1609278012	1	7	pc.
N 54 G2¼"		1609278013	1	5	pc.

The ball is made of stainless steel 1.4401.  
Max working pressure 16 bar  
Warranty for 5 years.



## Flange adapter

GROUP: G

Size [mm]	*	Code			UM
15 R1½"		1609090001	20	100	pc.
15 R1½"		1609090000	20	100	pc.
18 R1¼"		1609090011	20	100	pc.
18 R1½"		1609090010	20	100	pc.
22 R1¼"		1609090005	20	80	pc.
22 R1½"		1609090004	20	80	pc.
22 R1½"		1609090006	20	80	pc.
35 R2"		1609090007	10	30	pc.
42 R2¼"		1609090008	10	30	pc.
54 R2¾"		1609090012	5	20	pc.

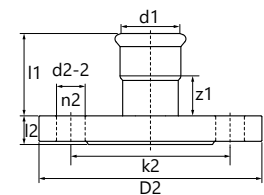


## Flange PN16

GROUP: G

Size [mm]	*	Code			UM
15		1609091004	1	15	pc.
18		1609091005	1	15	pc.
22		1609091006	1	12	pc.
28		1609091007	1	12	pc.
35		1609091001	1	6	pc.
42		1609091008	1	4	pc.
54		1609091009	1	2	pc.
76,1		1609091002	1	2	pc.
88,9		1609091003	1	2	pc.
108		1609091000	1	2	pc.

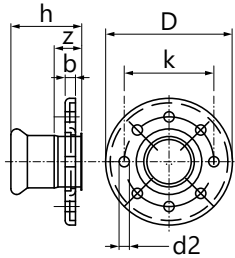
**Note:**  
Complete the flat gasket yourself.



Code	Size	l1	l2	z1	k2	D2	d2-2	n2
1609091004	15 DN15 PN16	43	13	23	65	95	14	4
1609091005	18 DN15 PN16	44	13	24	65	95	14	4
1609091006	22 DN20 PN16	45	14	24	75	105	14	4
1609091007	28 DN25 PN16	49	16	26	85	115	14	4
1609091001	35 DN32 PN16	51	17	26	100	140	18	4
1609091008	42 DN40 PN16	59	18	29	110	150	18	4
1609091009	54 DN50 PN16	69	18	34	125	165	18	4
1609091002	76,1 DN65 PN16	108	18	53	145	185	18	4
1609091003	88,9 DN80 PN16	127	20	64	160	200	18	8
1609091000	108 DN100 PN16	147	20	70	180	220	18	8

coil bar pipes in tube bag carton box pallet **N** new **i** available soon

\* custom-made - lead time max 4 weeks | \*\* availability as agreed | \*\*\* while stock lasts



## Flange PN16

**GROUP: G**

Size [mm]	*	Code			UM
139,7	**	<b>1609091010</b>	1	1	pc.
168,3	**	<b>1609091011</b>	1	1	pc.

**Note:**  
Complete the flat gasket yourself.

Code	Size	D	k	b	d2	h	z	n2
1609091010	139,7 DN125 PN16	250	210	22	18	138	41	8
1609091011	168,3 DN150 PN16	285	240	24	22	171	54	8


coil 
 bar 
 pipes in tube 
 bag 
 carton box 
 pallet 
 new 
 available soon

\* custom-made - lead time max 4 weeks | \*\* availability as agreed | \*\*\* while stock lasts

## Accessories

### O-Ring LBP EPDM Steel/Inox

GROUP: I

Size [mm]	*	Code			UM
12	*	1509182021	20	1000	pc.
15		1509182022	20	600	pc.
18		1509182023	20	500	pc.
22		1509182024	20	500	pc.
28		1509182025	20	400	pc.
35		1509182026	20	400	pc.
42		1509182027	20	300	pc.
54		1509182028	20	300	pc.


**Note:**

LBP EPDM O-Rings can be used in KAN-therm Steel and Inox systems.



### O-Ring LBP FPM Viton Steel/Inox

GROUP: I

Size [mm]	*	Code			UM
15		1509182030	20	600	pc.
18		1509182029	20	500	pc.
22		1509182031	20	500	pc.
28		1509182032	20	400	pc.
35		1509182033	20	400	pc.
42		1509182034	20	300	pc.
54		1509182035	20	300	pc.



**Note:**

LBP FPM/Viton O-Rings can be used in KAN-therm Steel and Inox systems.  
Do not use in hot water installations.



### O-Ring EPDM Steel/Inox

GROUP: I

Size [mm]	*	Code			UM
76,1		1609182023	5	100	pc.
88,9		1609182024	5	100	pc.
108		1609182025	5	50	pc.
139,7		1609182016	-	1	pc.
168,3		1609182017	-	1	pc.

**Note:**

O-Rings 76,1-108 can be used in KAN-therm Steel and Inox systems.  
O-Ring 66,7 is used for KAN-therm Steel fittings only.



### O-Ring FPM Viton Steel/Inox

GROUP: I

Size [mm]	*	Code			UM
76,1		1609182020	5	100	pc.
88,9		1609182021	5	100	pc.
108		1609182022	5	50	pc.
139,7	**	1609182018	-	1	pc.
168,3	**	1609182019	-	1	pc.

**Note:**

O-Rings 76,1-108 can be used in KAN-therm Steel and Inox systems.  
O-Ring 66,7 is used for KAN-therm Steel fittings only.  
Do not use in hot water installations.





 coil  bar  pipes in tube  bag  carton box  pallet  new  available soon

\* custom-made - lead time max 4 weeks | \*\* availability as agreed | \*\*\* while stock lasts



## Flat gasket FPM Viton Steel/Inox

**GROUP: I**

Size [mm]	*	Code			UM
15-18		<b>1509237000</b>	20	500	pc.
22		<b>1509237001</b>	20	500	pc.
28		<b>1509237002</b>	20	400	pc.
35		<b>1509237003</b>	20	400	pc.
42		<b>1509237004</b>	20	300	pc.
54		<b>1509237005</b>	20	300	pc.


**Note:**

FPM Viton flat gaskets can be used in KAN-therm Steel and Inox systems.  
 Gasket for unions and half unions of KAN-therm Steel and Inox systems.  
 Do not use in hot water installations.

## Tools

### Roller cutter for pipes


GROUP: K

Range [mm]	*	Code		UM
12-54		1948267025	1	pc.
35-108		1948267027	1	pc.



### Cutting wheel for roller cutter

GROUP: K

Range [mm]	*	Code		UM
12-108		1941267037	1	pc.

Intended for roller cutters, codes: 1948267025, 1948267027.



### Pipe cutting machine

GROUP: K


Range [mm]	*	Code		UM
22-108		1948183001	1	pc.

**Note:**  
The set includes a cutting wheel.



### Pipe cutting machine

GROUP: K


Range [mm]	*	Code		UM
54-168,3		1948267034	1	pc.

**Note:**  
The set does not include a cutting wheel.



### Cutting wheel for pipe cutting machine

GROUP: K

Range [mm]	*	Code		UM
22-168,3		1941267041	1	pc.

Intended for pipe cutting machines, codes: 1948183001, 1948267034.



### Pipe support for cutting machine

GROUP: K

	*	Code		UM
		1948267029	1	pc.



 coil  bar  pipes in tube  bag  carton box  pallet **N** new **i** available soon

\* custom-made - lead time max 4 weeks | \*\* availability as agreed | \*\*\* while stock lasts



### Deburrer for metal pipes

GROUP: K

Range [mm]	*	Code		UM
12-54		1948267015	1	pc.



### Tool set - deburrer and roller cutter

GROUP: K

Range [mm]	*	Code		UM
12-54	*	1948267023	1	set

Each set includes:

- 1948267025 - roller cutter for steel pipes 12-54 mm
- 1948267015 - chamferer 12-54 mm
- 1941267129 - case



### Tool set - KAN-therm Mini battery press tool + "M" profile jaws

GROUP: K

Range [mm]	*	Code		UM
15-28		1936055009	1	pc.

Each set includes:

- 1936055008 - KAN-therm Mini press tool - 1 pc.
- 1936267278 - jaws SBM M15 - 1 pc.
- 1936267279 - jaws SBM M18 - 1 pc.
- 1936267280 - jaws SBM M22 - 1 pc.
- 1936267282 - jaws SBM M28 - 1 pc.
- 1967267051 - battery RAML1225 Li-Ion 10,8 V 2,5 Ah - 2 pcs.
- 1967267024 - charger LGML1 ~230 V 35 W
- case - 1 pc.



### KAN-therm AC 3000 electric press tool

GROUP: K

Range [mm]	*	Code		UM
12-54		1936267239	1	pc.

**Note:**

The press tool is sold in a case.



### KAN-therm DC 4000 battery press tool

GROUP: K

Range [mm]	*	Code		UM
12-54		1936267238	1	pc.

**Note:**

The press tool is sold with a battery, charger and case.



### Charger for KAN-therm DC 4000 battery press tool

GROUP: K

Version	*	Code		UM
10,8-36 V		1936267267	1	pc.

coil bar pipes in tube bag carton box pallet **N** new available soon

\* custom-made - lead time max 4 weeks | \*\* availability as agreed | \*\*\* while stock lasts



### Battery for KAN-therm DC 4000 press tool

GROUP: K

Version	*	Code		UM
N 18 V / 4 Ah		1936267266	1	pc.



### KAN-therm "M" profile press jaws

GROUP: K


Size [mm]	*	Code		UM
N 12		1936267248	1	pc.
N 15		1936267249	1	pc.
N 18		1936267250	1	pc.
N 22		1936267251	1	pc.
N 28		1936267252	1	pc.
N 35		1936267253	1	pc.



**Note:**  
The jaws work with KAN-therm: AC 3000, DC 4000 drives.

### KAN-therm "M" profile collar

GROUP: K

Size [mm]	*	Code		UM
N 42		1936267283	1	pc.
N 54		1936267284	1	pc.



**Note:**  
Use KAN-therm "M" profile collar jaws with KAN-therm ZBS1 adapter for KAN-therm press tools: AC 3000, DC 4000.

### ZBS1 adapter for KAN-therm "M" profile collar jaws

GROUP: K


Range [mm]	*	Code		UM
N 42 - 54		1936267285	1	pc.



**Note:**  
Use KAN-therm "M" profile collar jaws with KAN-therm ZBS1 adapter for KAN-therm press tools: AC 3000, DC 4000.

### REMS Power-Press ACC electric press tool

GROUP: K

Range [mm]	*	Code		UM
12-54		1936267219	1	pc.



**Note:**  
The press tool is sold with a case.  
The set does not include jaws.



### REMS Power-Press SE Basic Pack electric press tool

GROUP: K

Range [mm]	*	Code		UM
12-54		1936267160	1	pc.

**Note:**  
The press tool is sold with a case.  
The set does not include jaws.



### REMS Akku Press battery press tool

GROUP: K

Range [mm]	*	Code		UM
12-54		1936267152	1	pc.

**Note:**  
The press tool is sold with a battery, charger and case.  
The set does not include jaws.



### REMS "M" profile press jaws

GROUP: K

Size [mm]	*	Code		UM
12		1948267046	1	pc.
15		1948267048	1	pc.
18		1948267052	1	pc.
22		1948267056	1	pc.
28		1948267061	1	pc.
35		1948267065	1	pc.
42		1948267067	1	pc.
54		1948267069	1	pc.

**Note:**  
The jaws work with Power-Press SE, Akku-Press, Power-Press ACC drives.



### Set of REMS "M" profile press jaws

GROUP: K

Range [mm]	*	Code		UM
42-54		1948267130	1	set

Each set includes:

- 1948267067 - jaws M42 - 1 pc.
- 1948267069 - jaws M54 - 1 pc.
- case.

Jaws work with Power-Press SE, Akku-Press, Power-Press ACC drives.



### REMS tool set - electric Power-Press SE press tool and "M" profile jaws

GROUP: K

Range [mm]	*	Code		UM
15-35		1948267033	1	set

Each set includes:

- 1936267160 - electric press tool REMS Power-Press SE
- 1948267048 - jaws M15 - 1 pc.
- 1948267052 - jaws M18 - 1 pc.
- 1948267056 - jaws M22 - 1 pc.
- 1948267061 - jaws M28 - 1 pc.
- 1948267065 - jaws M35 - 1 pc.
- case.

## Novopress tool set - ACO103 BT battery press tool + "M" profile jaws

GROUP: K

Range [mm]	*	Code		UM
15-28	*	1948055008	1	pc.

Each set includes:

- battery press tool - 1 pc.
- 1948267093 - jaws M15 for press tool - 1 pc.
- 1948267095 - jaws M18 for press tool - 1 pc.
- 1942121002 - jaws M22 for press tool - 1 pc.
- 1948267097 - jaws M28 for press tool - 1 pc.
- 1938267047 - charger - 1 pc.
- 1938267002 - battery 2 Ah - 2 pcs.
- case



## Novopress EFP203 electric press tool

GROUP: K

Range [mm]	*	Code		UM
12-54		1948267210	1	pc.


**Note:**

The press tool is sold with a plastic case.



## Novopress ACO203XL BT press tool

GROUP: K

Range [mm]	*	Code		UM
12-108		1948267181	1	pc.


Each set includes:

- Battery press tool - 1 pc.
- Battery 18 V/ 5.0 Ah Li-Ion Milwaukee - 2 pcs.
- Charger - 1 pc.
- Lubricant - 1 pc.
- Plastic case



## Novopress PB2 "M" profile press jaws

GROUP: K

Size [mm]	*	Code		UM
12		1948267134	1	pc.
15		1948267135	1	pc.
18		1948267137	1	pc.
22		1948267139	1	pc.
28		1948267141	1	pc.
35		1948267143	1	pc.

**Note:**

The jaws work with EFP203 and ACO203XL drives.





## Novopress "M" profile Snap On collar

GROUP: K

Size [mm]	*	Code		UM
42		1948267119	1	pc.
54		1948267121	1	pc.
66,7	*	1948267089	1	pc.
76,1		1948267145	1	pc.
88,9		1948267044	1	pc.
108		1948267038	1	pc.

**Note:**

Use jaws for diameters 66,7, 76,1 and 88,9 mm with adapter ZB221 for ACO203XL.  
Use the jaw with a diameter of 66,7 mm with adapter ZB323 for ECO301.  
Use the jaw with a diameter of 108 mm with adapter ZB221 and ZB222 for ACO203XL.



## HP Snap On collar for Novopress ECO301, ACO203XL, EFP203

GROUP: K

Size [mm]	*	Code		UM
35	*	1948267124	1	pc.
42	*	1948267126	1	pc.
54	*	1948267128	1	pc.

**Note:**

Jaws for diameters 35-54 mm with ECO301 press tool use with ZB303 adapter.  
Jaws for diameters 35-54 mm with ACO203XL and EFP203 crimping tool use with ZB203 adapter.  
Do not use 54 jaw with the ACO203XL and EPF203 press tool to make connections with 54 mm diameter KAN-therm Inox system pipes (1.4404 and 1.4521).



## Novopress ZB203 adapter

GROUP: K

Range [mm]	*	Code		UM
35-54		1948267000	1	pc.

**Note:**

Adapter for EFP203 and ACO203XL drives.  
Press: 50-63 mm  
Steel & Inox: 35-54 mm  
Copper: 42-54 mm



## Novopress ZB221 Adapter

GROUP: K

Range [mm]	*	Code		UM
66,7-108		1948267005	1	pc.

**Note:**

Adapter for ACO203XL drive.  
For a diameter of 108 mm, adapter ZB221 is used to make the first crimp, and adapter ZB222 for the second crimp.



## Novopress ZB222 Adapter

GROUP: K

Range [mm]	*	Code		UM
66,7-108		1948267007	1	pc.

**Note:**

Adapter for ACO203XL drive.  
For a diameter of 108 mm, adapter ZB221 is used to make the first crimp, and adapter ZB222 for the second crimp.

## Novopress ACO403 battery press tool

GROUP: K

Range [mm]	*	Code		UM
76,1-168,3		1948267209	1	pc.


Each set includes:

- Battery press tool - 1 pc.
- Battery 18 V/ 5.0 Ah Li-Ion Milwaukee - 2 pcs.
- Charger - 1 pc.
- Lubricant - 1 pc.
- Plastic case



## Novopress "M" profile HP Snap On collar

GROUP: K

Size [mm]	*	Code		UM
76,1	*	1948267100	1	pc.
88,9	*	1948267102	1	pc.
108	*	1948267098	1	pc.
139,7		1948267071	1	pc.
168,3		1948267072	1	pc.

**Note:**

The jaws work with ACO401 and ACO403 drives.







Install your **future**



SYSTEM **KAN-therm**

# Surface heating & cooling

Comfort and efficiency

## 4 SYSTEM **KAN-therm** radiant surface heating and cooling

<b>4.1 Basic information</b>	<b>154</b>
<b>4.2 Thermal comfort</b>	<b>155</b>
<b>4.3 KAN-therm system surface heating and cooling - elements</b>	<b>156</b>
<b>4.4 Pipes</b>	<b>156</b>
<b>4.5 Edge and damp-proof insulation</b>	<b>160</b>
<b>4.6 Thermal insulation</b>	<b>160</b>
<b>4.7 Heating/cooling plate design</b>	<b>161</b>
<b>4.8 Manifolds</b>	<b>163</b>
Manifolds for underfloor heating (U)	<b>164</b>
<b>4.9 Mixing systems</b>	<b>167</b>
<b>4.10 Installation cabinets</b>	<b>169</b>
<b>4.11 Design of floor heaters - pipe fastening system</b>	<b>170</b>
KAN-therm Tacker system	<b>170</b>
KAN-therm Profil system	<b>171</b>
KAN-therm TBS system	<b>172</b>
KAN-therm Rail system	<b>173</b>
KAN-therm NET system	<b>173</b>
<b>4.12 Execution of floor screed</b>	<b>174</b>
<b>4.13 Assembly</b>	<b>175</b>
<b>4.14 Construction of wall heaters/coolers - pipe fastening systems</b>	<b>176</b>
Wet method	<b>176</b>
Dry method	<b>178</b>
<b>4.15 Automatic control of heating/cooling systems</b>	<b>179</b>
Basic+ automation	<b>180</b>
Basic+ thermostats	<b>181</b>
Basic+ weekly room thermostats	<b>182</b>
Additional elements Basic+	<b>182</b>
SMART automation	<b>183</b>
Automation additional elements	<b>186</b>
Rinsing, tightness tests of KAN-therm installations	<b>186</b>

### Surface heating and cooling in **KAN-therm** system - assortment

Wall/ceiling heating and cooling	<b>187</b>
Floor/wall heating and cooling	<b>189</b>
Tacker - pipe mounting system	<b>193</b>
Rail - pipe mounting system	<b>196</b>
Profil - pipe mounting system	<b>197</b>
TBS - pipe mounting system	<b>198</b>
NET - pipe mounting system	<b>199</b>
Floor heating accessories	<b>200</b>
Manifolds and manifold accessories	<b>203</b>
Floor heating cabinets	<b>219</b>
Basic+ - automation components	<b>221</b>
Smart - automation components	<b>225</b>
Controllers, additional accessories and tools	<b>228</b>



## 4 SYSTEM KAN-therm radiant surface heating and cooling

The KAN Company, manufacturer of the KAN-therm systems for many years promotes modern and user-friendly surface heating/cooling installations. The design of a system KAN-therm surface heating/cooling is very simple. Thanks to a large selection of design solutions, wide assortment of system elements (manifolds, installation cabinets and automation components) you can precisely select a heating/cooling system depending on the local conditions.

### **Among surface heating/cooling systems we offer:**

- heating of surfaces in contact with open air (sports field pitches, stadium pitches, transport routes, garage drives/ramps, external stairs and terraces),
- floor, ceiling and wall type heating/cooling inside buildings.
- For heating/cooling inside buildings different designs of surface heaters/coolers can be chosen depending on construction conditions, the use of a building etc:
- sports halls with elastic floors,
- wooden structure floors with an air void,
- poured structures of a floor heating or cooling – laid by a so-called wet method,
- structures of a floor heating or cooling laid by a dry method – especially useful for an overhaul or adaptation of buildings,
- structures of wall heating or cooling or cooling laid by wet method,
- structures of wall heating or cooling laid by dry method - especially useful for an overhaul or adaptation of buildings, as well as rooms with irregular shapes (e.g. attics).

### **Advantages of a system KAN-therm floor heating/cooling:**

- most efficient temperature distribution in a room,
- energy saving,
- possible cooperation with cost-effective heat or cold sources, e.g. heat pumps and condensing boilers,
- maximum use of the space surface,
- system friendly for allergists,
- in summer the system can cool spaces,
- high quality and reliability,
- competitive price,
- fast and easy assembly,
- rich selection of system designs,
- quiet run, no vibration,
- resistance against corrosion
- materials do not cover in limestone,
- environment friendly materials.

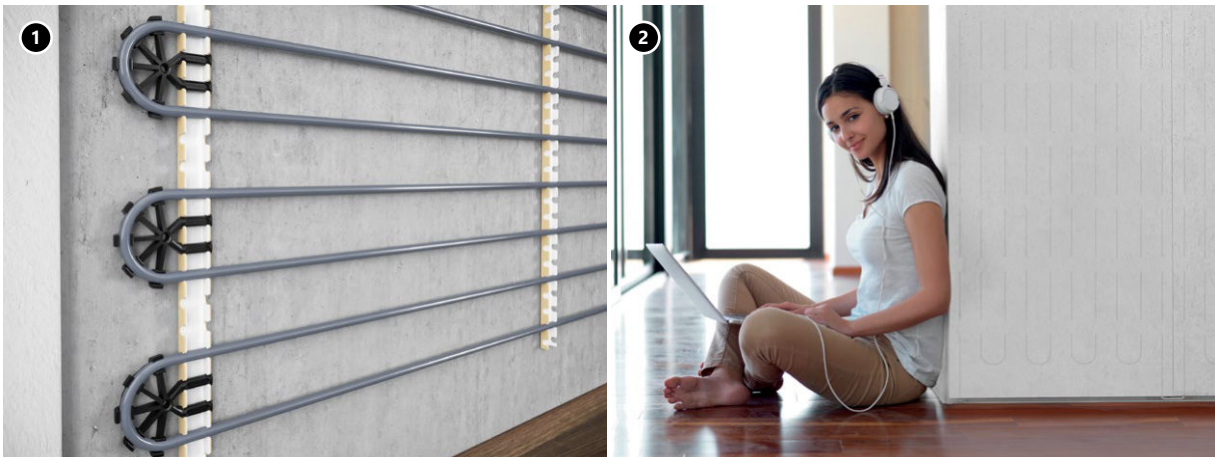
The KAN Company also supplies computer programmes aiding to design floor heating and cooling systems:

- **KAN CO-Graf** for designing heating systems with an option for designing a floor heating,
- **KAN Quick Surface** an web application Internet programme for a quick calculation of a floor heating or cooling based on the EN 1264 standard with an option of listing materials,
- **KAN HL ozc**, as an addition for calculating heat losses in buildings and individual spaces,
- **KAN SDG** is a programme for quick selection of floor heating and convection heaters, with an option to approximately calculate rooms design heat load.

All programmes are available at [www.kan-therm.com](http://www.kan-therm.com)

## 4.1 Basic information

The wall heating/cooling involves installation of heating/cooling pipes in the inner vertical layers of construction partitions. This can be achieved in two ways - by fixing the heating/cooling pipes to the construction layer and covering with plaster (wet method) or by finishing the inner surface of the walls with plasteboards with embedded heating/cooling pipes (dry method). Heating of this type not only provides optimum thermal comfort but also reduces heat loss from the room (transmission of heat from the warmer to the colder place through the partition of a higher temperature is physically impossible). Heating of this type is ideal for use in rooms with sloping walls (attics) which are difficult to arrange.



Wall heating/cooling:

1. laid using wet method - pipes covered with plaster.
2. laid with dry method - pipes embedded in gypsum fibre boards.

A floor heating/cooling is directly immersed in a poured on layer of screed (floor leveller). Thus a heater/cooler is made, which in fact is a floor itself.

This kind of heating/cooling is very popular and can be successfully used in one-family houses and high standard apartment buildings.

The floor heating system has turned out to be the best solution to maintain the best warmth comfort in the building industry, e.g:

- churches,
- public buildings (sports halls, exhibition halls),
- industrial buildings.



Wet laid floor heating/cooling – pipes embedded in a cast screed

## 4.2 Thermal comfort

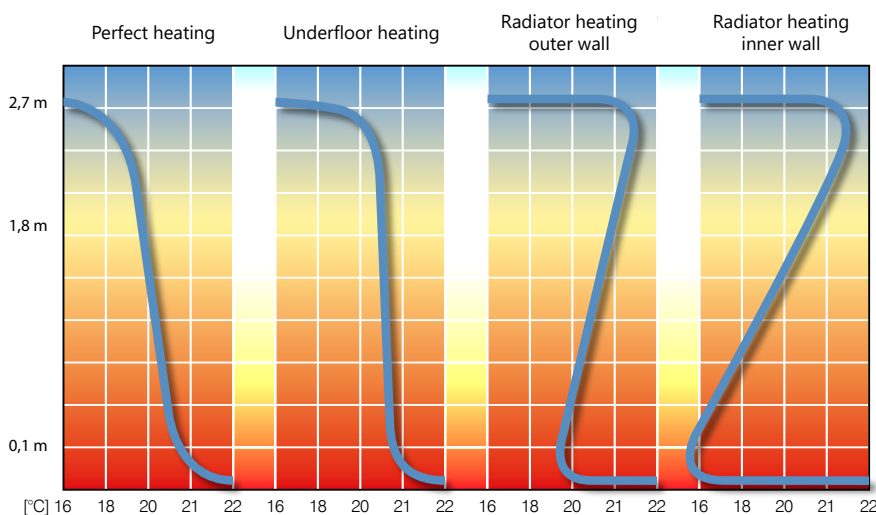
Surface heating is a heating system, where the most of the heat is given up by radiation. The heat flux is conducted by the pipe, then thru the concrete layer as the heating plate, and next thru the flooring and is given up to the environment.

The floor temperature is raised thus it is not a cold barrier (does not cool feet) and does not negatively affect the wind chill (the resultant of the air temperature, wall temperature and floor temperature in a room), which decides on the warmth comfort.

Therefore the air temperature in a room of 20°C provides the same thermal comfort as 21°C - 22°C, achieved with traditional heaters and convectors. The human body does not feel variations of the room temperature by 1°C.

With the floor and wall heating a heat distribution almost ideal for the human is achieved.

What's important with a surface heating is the reduced air convection as compared to radiators (convection type), which can raise dust.



Vertical distribution of temperature for various types of heating

### 4.3 KAN-therm system surface heating and cooling - elements



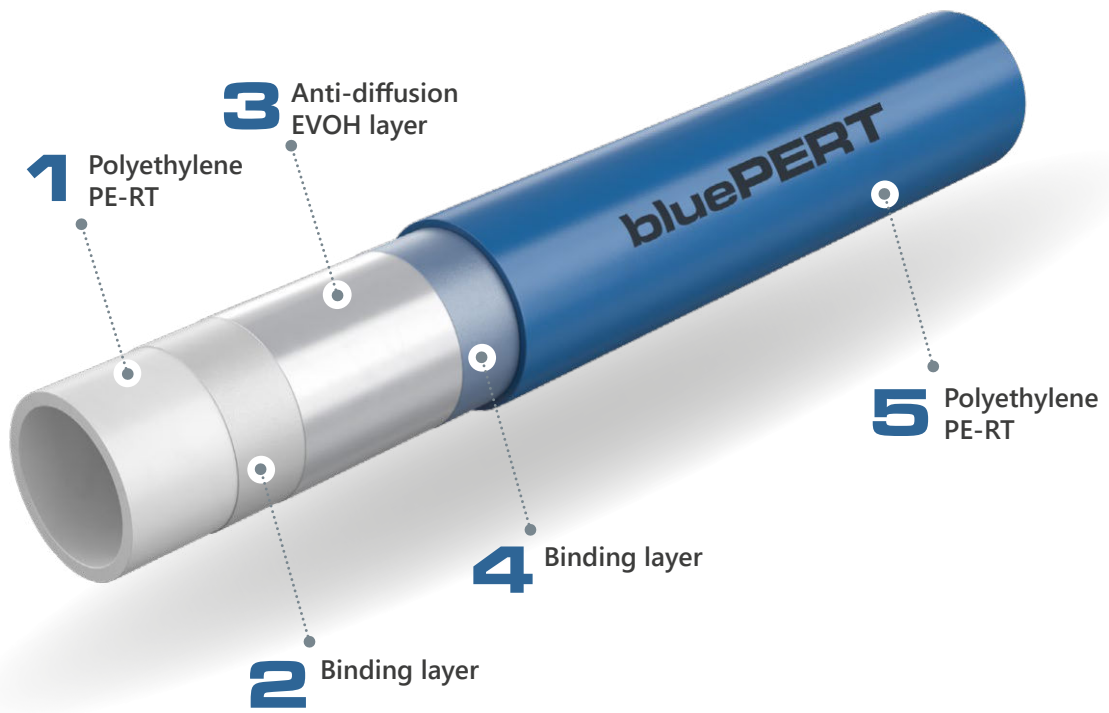
Components of KAN-therm surface heating/cooling

### 4.4 Pipes

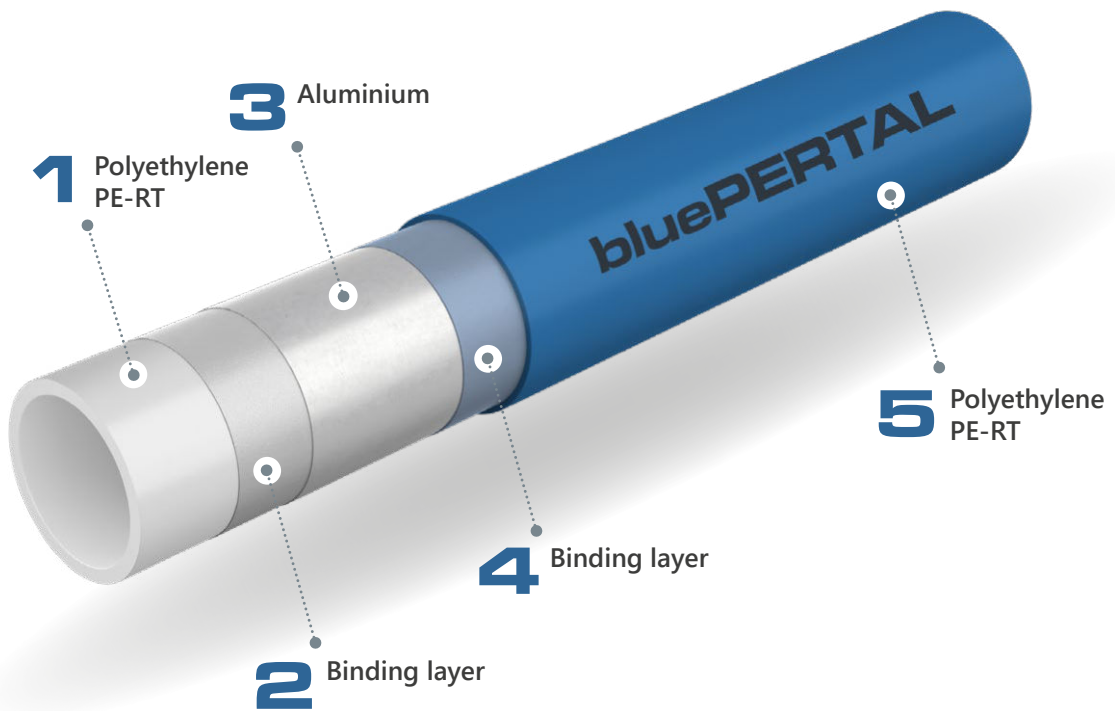
Plastic pipes laid and fixed to styrofoam sheets are the heating/cooling element of the KAN-therm system.

The KAN-therm system for floor and wall heating/cooling offers a very wide assortment of pipes both in terms of diameters and types. This allows selecting a best technical and cost-effective solution to satisfy all customers' requirements.

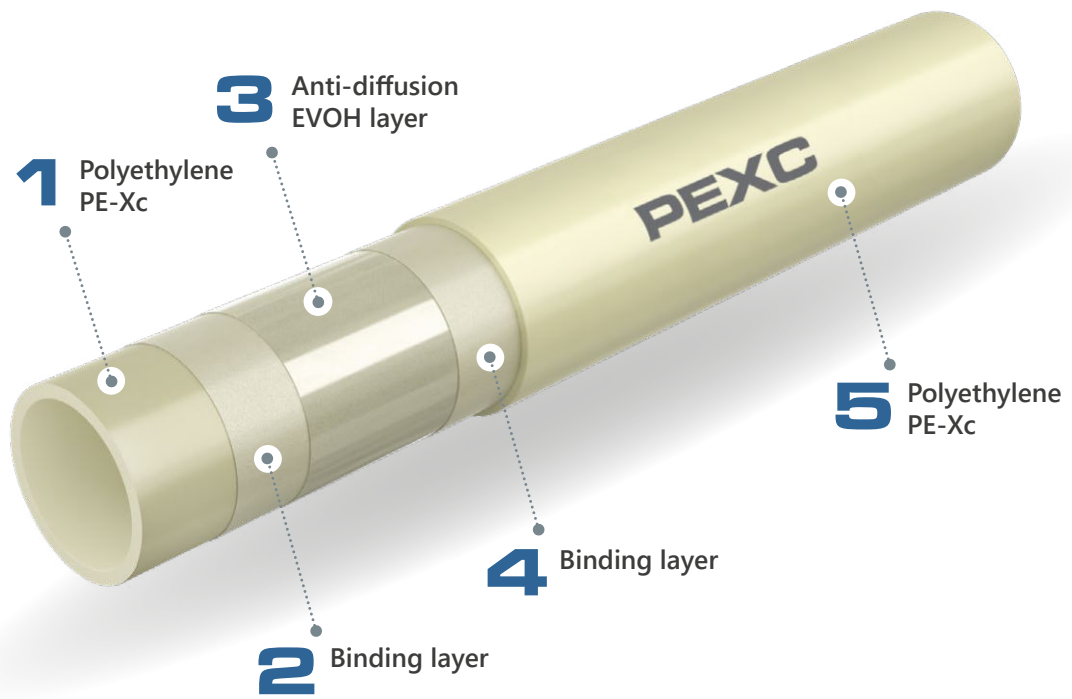
For construction of a KAN-therm floor heating/cooling two kinds of plastic pipes can be used: PEXC, PERT<sup>2</sup>, PERT and bluePERT with anti-diffusion barrier (EVOH layer) or multilayer PERTAL<sup>2</sup>, PERTAL and bluePERTAL pipes with an aluminium layer. Depending on the required heat/cold capacity of a floor heating/cooling system we use pipes of a diameter between Ø12 and 26 mm. For wall heating/cooling system we use Ø8 – 16 mm pipes covered with a special plaster or in finished panels mounted on the wall.



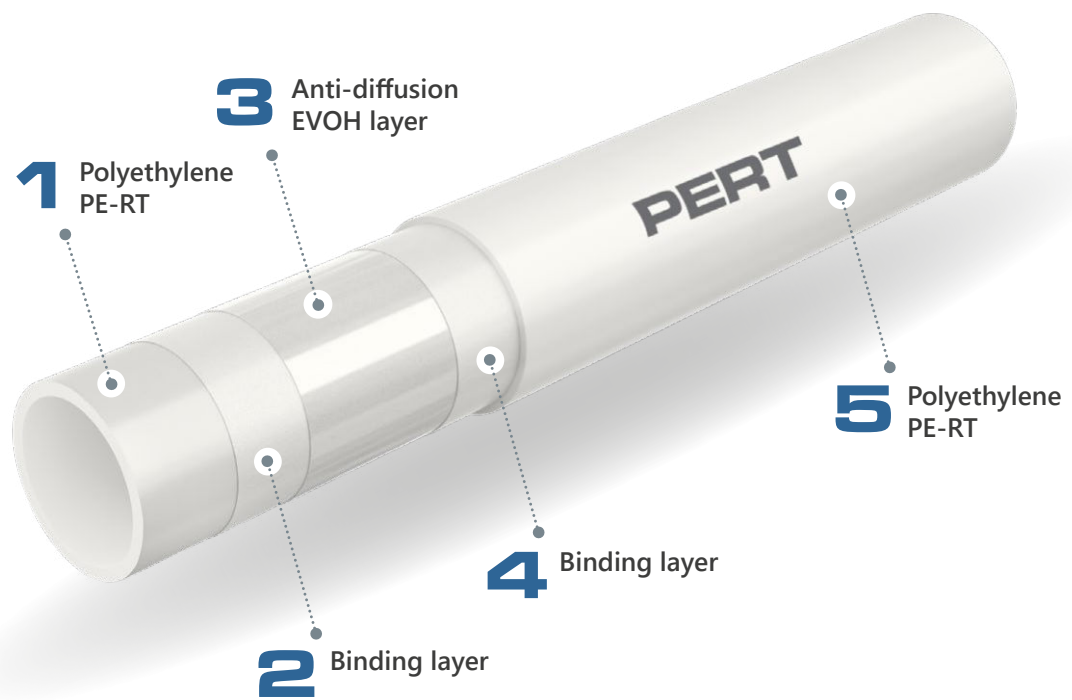
Design of bluePERT pipe with EVOH layer



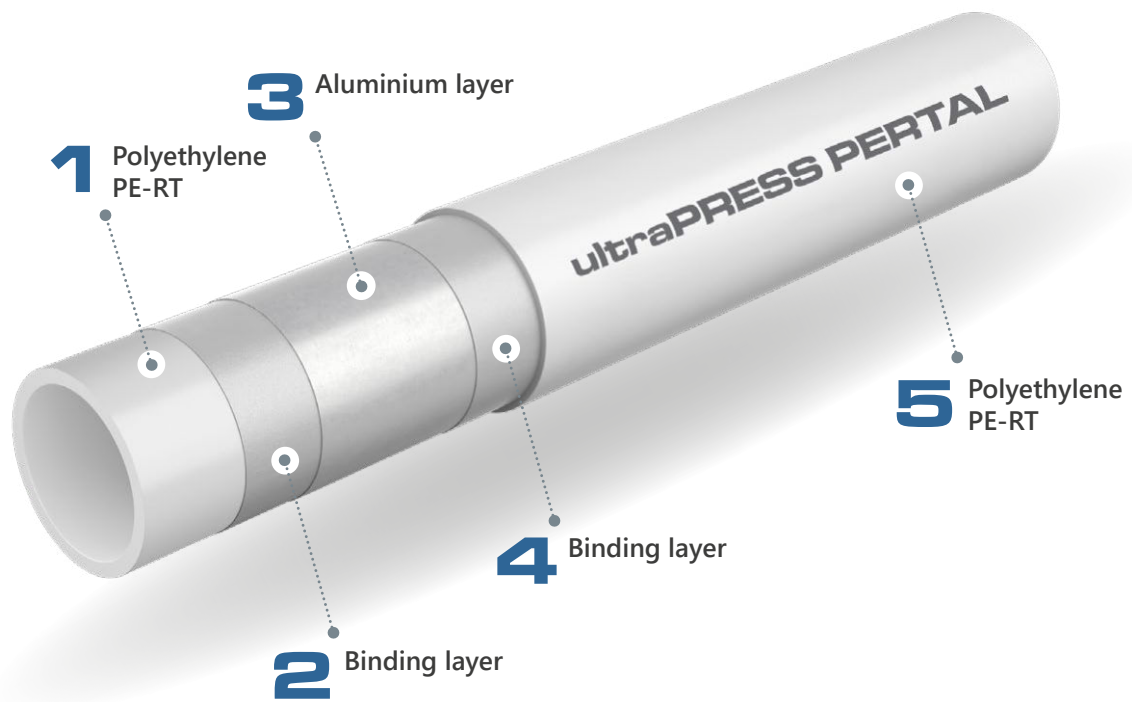
Design of bluePERTAL pipe with aluminium layer



Design of PEXC pipe with EVOH layer



Design of PERT pipe with EVOH layer



Design of PERTAL pipe with aluminium layer

Pipes are available in 100-600 m coils depending on the pipe diameter. The use of pipe uncoiler makes it possible to form heating coils fast and easy without turning them around their axis. Turning pipes around their axis causes tensions and a tendency of a pipe to separate from a substrate therefore forces to make it fast to the substrate must be greater.



1. Pipe in coil
2. Uncoiler for pipe coils
3. uncoiler guide

## 4.5 Edge and damp-proof insulation

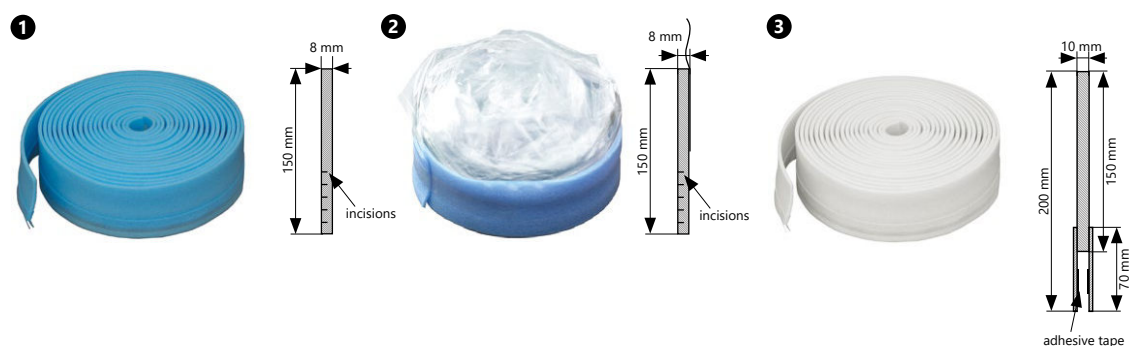
Damp proof insulation elements:

- PE foil in rolls,
- metalized or laminated foil on Tacker boards,
- PS-foil on Profil panels.

Dilatation tapes:

- reduces heat losses through walls;
- constitutes dilatation of concrete heating panel from outer walls and structural components,
- laid up to concrete layer high (in case of ceramic floor covering, also ceramic covering should have dilatation from walls and structural components).

Selection of edge insulation:



1. Wall tape with incision.
2. Wall tape with incision and with skirt.
3. Expansion joint profile with feet.

## 4.6 Thermal insulation

Requirements for thermal insulation to EN 1264:

- $R = 0,75 \text{ [m}^2\text{K/W]}$  – required insulation thermal resistance above a heated space,
- $R = 1,25 \text{ [m}^2\text{K/W]}$  – required insulation thermal resistance above a not heated space or on the ground ( $T_z \geq 0 \text{ }^\circ\text{C}$ ),
- $R = 2,00 \text{ [m}^2\text{K/W]}$  – required insulation thermal resistance on the ground ( $-5 \text{ }^\circ\text{C} \geq T_z \geq -15 \text{ }^\circ\text{C}$ ).

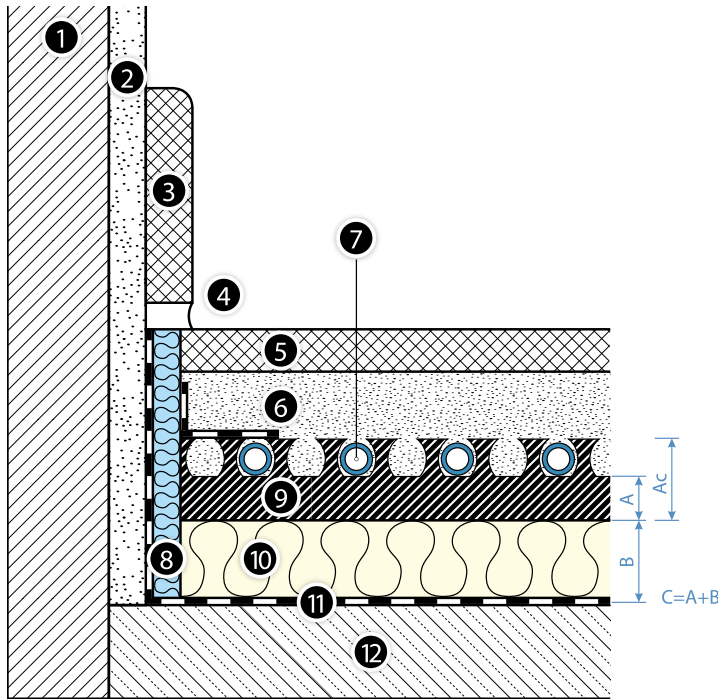
Thermal insulation elements:

- Styrofoam sheets Tacker with a metalised or laminated foil 20, 30, 35 and 50 mm thick,
- Styrofoam sheets Profil – Profil1 and Profil2, 30 or 11 mm thick,
- Styrofoam sheets TBS – thickness 25 mm.

When you lay styrofoam on a bitumen substrate use a separating PE-foil.

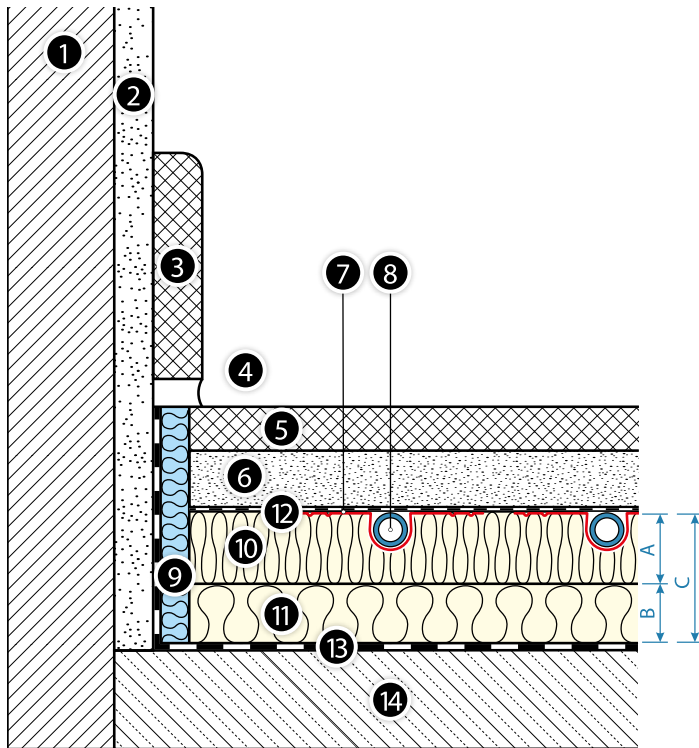


## 4.7 Heating/cooling plate design



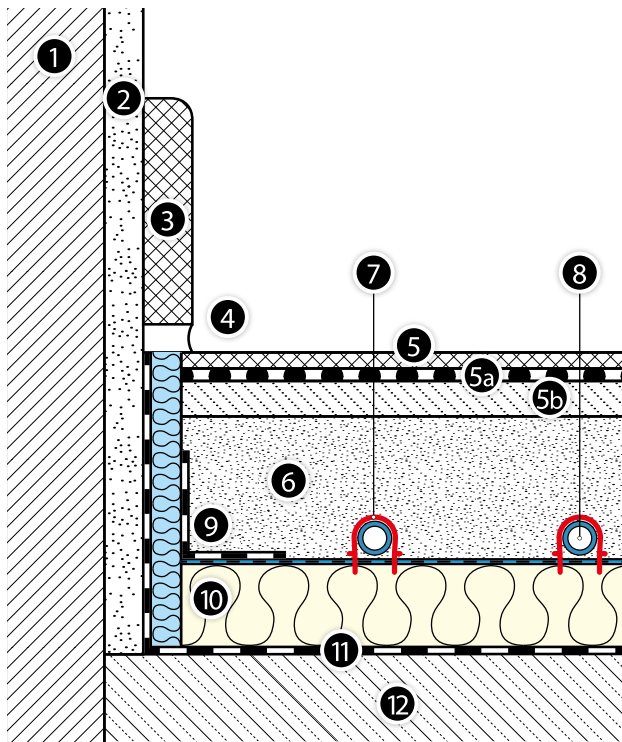
**Fig. 1.** Floor heater with KAN-therm Profil system board and supplementary insulation and damp-proof coating on the ceiling laid out on the ground.

1. Wall.
2. Plaster layer.
3. Baseboard.
4. Armor joint.
5. Floor lining.
6. Screed.
7. KAN-therm pipe
8. Wall tape with PE protective apron.
9. KAN-therm Profil system board of insulation thickness A and total height Ac.
10. Supplementary board of thickness B.
11. Damp insulation (only at the ground!).
12. Concrete ceiling.

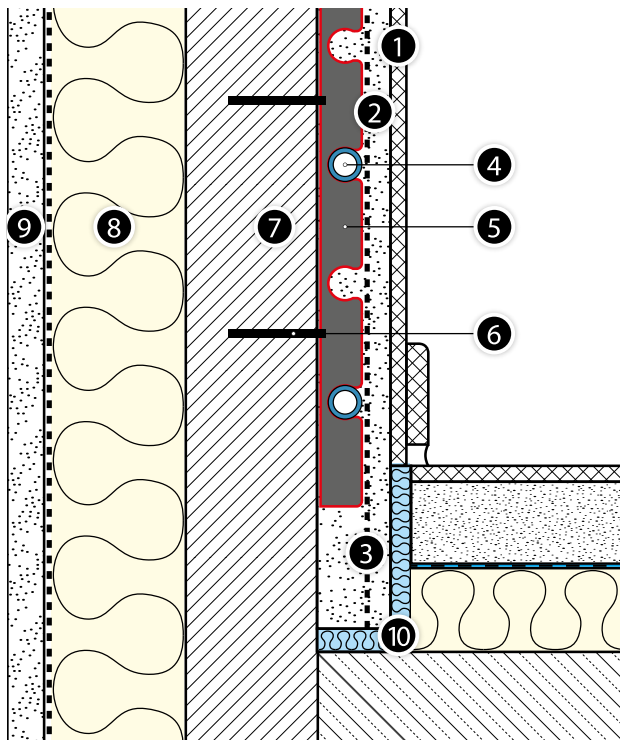


**Fig. 2.** Floor heater with KAN-therm TBS system board and supplementary insulation and damp-proof coating on the ceiling laid out on the ground.

1. Wall.
2. Plaster layer.
3. Baseboard.
4. Armor joint.
5. Floor lining.
6. Dry screed.
7. Steel radiator (lamella).
8. KAN-therm pipe.
9. Wall tape.
10. KAN-therm TBS system board of thickness A.
11. Supplementary board of thickness B.
12. PE foil.
13. Damp insulation (only at the ground!).
14. Concrete ceiling.



1. Wall.
2. Plaster layer.
3. Baseboard made of tiles.
4. Armor joint.
5. Sport floor lining.
- 5a. Coating with glass fiber.
- 5b. Elastic layer 10 mm.
6. Screed.
7. Pipe clip.
8. KAN-therm pipe.
9. Wall tape with PE protective apron.
10. KAN-therm Tacker system board of thickness A with metallised or laminated foil.
11. Damp insulation (only at the ground!).
12. Concrete ceiling.



1. Wallcovering (wallpaper, ceramic tiles)
2. Plaster
3. Mounting mesh 7×7 mm
4. KAN-therm pipe
5. Mounting rail
6. Dowel
7. Wall construction
8. Thermal insulation
9. External plaster
10. Expansion joints

For detailed requirements for heating/cooling plates designs see 'Guidebook surface heating and cooling' delivered by KAN company.

## 4.8 Manifolds

The wide array of variants of the KAN-therm InoxFlow manifolds covers the old brass designs in 100 % and replaces them in the KAN-therm offer.

The basic adjustment of the surface heating or cooling consists of the equalisation of flow resistance through individual coils to ensure an even water flow distribution.

This regulation can be done with:

- control valves,
- control and measuring valves (flowmeters).

**There are various designs of manifolds for surface heating or cooling available in the offer of system KAN-therm:**

- InoxFlow manifolds made of 1.4301 stainless steel, with the beam cross-section of 1 ¼"
- Brass manifolds with 1" cross-section, with servomotor valves and flowmeters
- Plastic manifolds with flowmeters and shut-off valves
- InoxFlow and brass manifolds have 1" female threads for connecting to beams and outputs for individual circuits in the form of male ¾" nipples (Eurocone sockets), with the spacing of 50 mm.
- M30x1,5 (InoxFlow) or M28x1,5 mm (brass manifolds) threads in manifolds equipped with valves for electric servomotors.
- A part of the manifolds is equipped with control and measuring flowmeters.
- It is crucial to ensure that the flowmeter works in the direction of the medium flow: red flowmeters are used on the supply beam (scale from top to bottom), black flowmeters are used on the return beam (scale from the bottom to top).

The manifolds with flowmeters can work with the following parameters:

- 60 °C / 6 bar ( $T_{max} = 70\text{ °C}$ )

while the manifolds without flowmeters can work with the following parameters:

- 80 °C / 10 bar ( $T_{max} = 90\text{ °C}$ )

### MARKING OF MANIFOLD SERIES



|                      |                      |

**R or U    B,N,S,V or F    T, A or P**

	<b>equipment of top or bottom beams</b>	<b>additional accessories</b>
<p><b>Radiator</b> manifolds for central heating and drinking water</p> <p><b>Underfloor heating</b> manifolds for underfloor heating</p>	<p><b>Basic</b> no accessories</p> <p><b>Nipples</b></p> <p><b>Servomotor valves</b></p> <p><b>Valves</b> shut-off or balancing valve</p> <p><b>Flowmeters</b></p>	<p><b>Top</b> air-vent on top of the beam</p> <p><b>Axis</b> air-vent in the axis of the beam</p> <p><b>Pump</b> mixing unit</p>

## Manifolds for underfloor heating (U)

with flowmeters



### InoxFlow – UFST and UFST MAX series

Manifolds with flowmeters  
and servomotor valves  
and venting section



### InoxFlow – UFS series

Manifolds with flowmeters  
and servomotor valves



### InoxFlow – UFN series

Manifolds with flowmeters

with control valves



**InoxFlow – UVST series**

Manifolds with control valves  
and servomotor valves  
and venting section



**InoxFlow – UVS series**

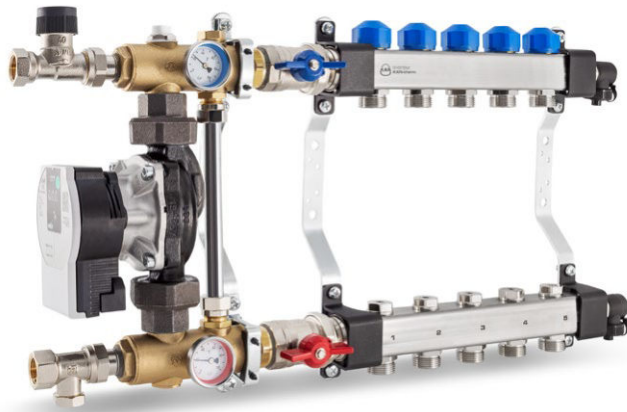
Manifolds with control  
and servomotor valves



**InoxFlow – UVN series**

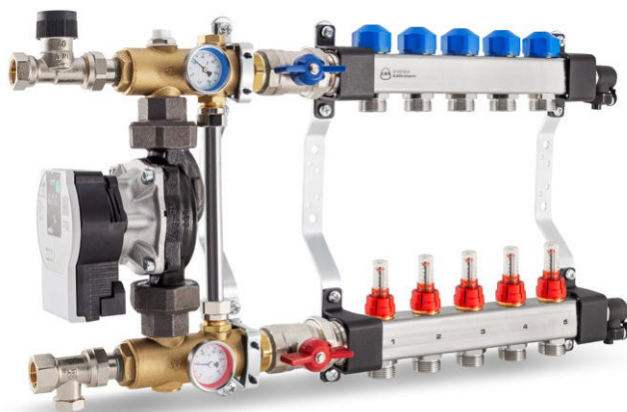
Manifolds with control valves

## KAN-therm surface heating manifolds with mixing system



### USVP series

Manifolds with mixing unit and with control valves, servomotor valves and venting section



### USFP series

Manifolds with mixing unit and with flowmeters, servomotor valves and venting section

## Plastic manifolds for surface heating/cooling



### Plastic manifolds

Manifolds with flowmeters, shut-off valves, thermometers and venting section.

Available in two versions:

1½" × ¾" or 1½" × 1"

## 4.9 Mixing systems

Radiant heating requires lower supply temperature than radiator heating. The maximum temperature of supplying water should not exceed 55 °C. Therefore, in case of a common heating thermal source with radiators, the solutions, which lower the temperature of power supply, should be applied. The systems based on mixing the heating water flowing from the heating source with surface heating installation return water are available in KAN-therm system.

KAN-therm surface heating can also be directly supplied from low-temperature heat sources, such as condensing boilers or heat pumps.



**Local mixing units: are used in case a surface heating is planned within one storey. These sets shall be installed in installation cabinets, close that a heating installation cabinets, near the underfloor heating system.**

InoxFlow USVP and USFP series manifold connected directly to a heating system operates as a local mixing system. A thermostatic head with a capillary tube serves as a protection against a possible temperature rise. It can be adjusted "down" from 55 °C.

Caution! do not use with low temperature heat sources.

KAN-therm local mixing systems are applied in high-temperature installations (radiator) when there is a need to ensure a heating medium of lower parameters for a coil unit, supported by a single manifold. Lowering the supply temperature to the values proper for surface heatings takes place on the basis of pumping mixing. It is a system of constant temperature, implemented through quantity adjustment. Such system is not suitable for low temperature heating sources (below 60 °C).

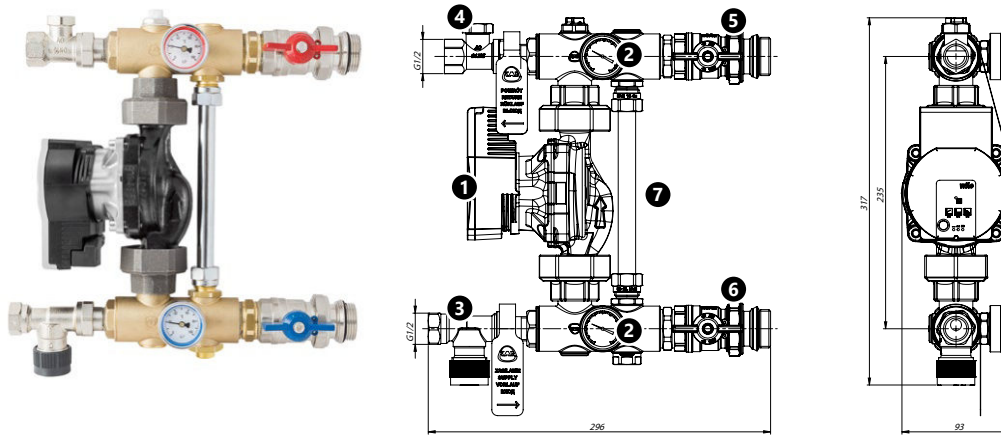


Fig. 3. KAN-therm pump unit design.

1. glandless electronic pump Wilo PARA 25/6
2. dial thermometers
3. ZT female thread 1/2" thermostatic valve
4. ZR female thread 1/2" control valve
5. G1" cut-off valve of the supplying beam
6. G1" cut-off valve of the return beam
7. by-pass with control valve

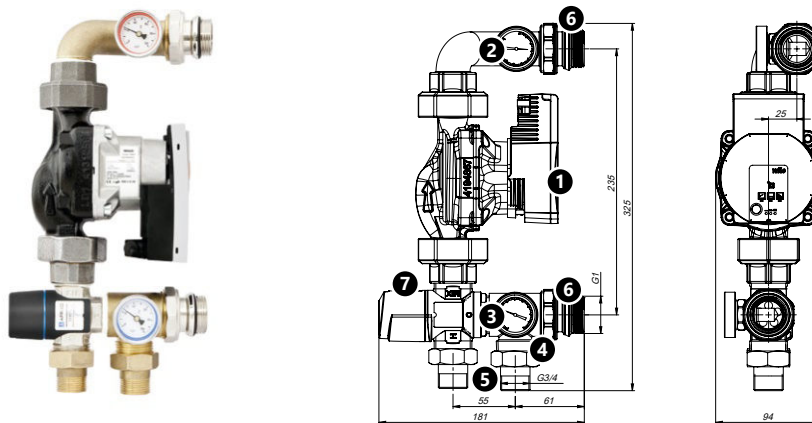


Fig. 4. Construction of mixing unit with 3-way thermostatic valve KAN-therm.

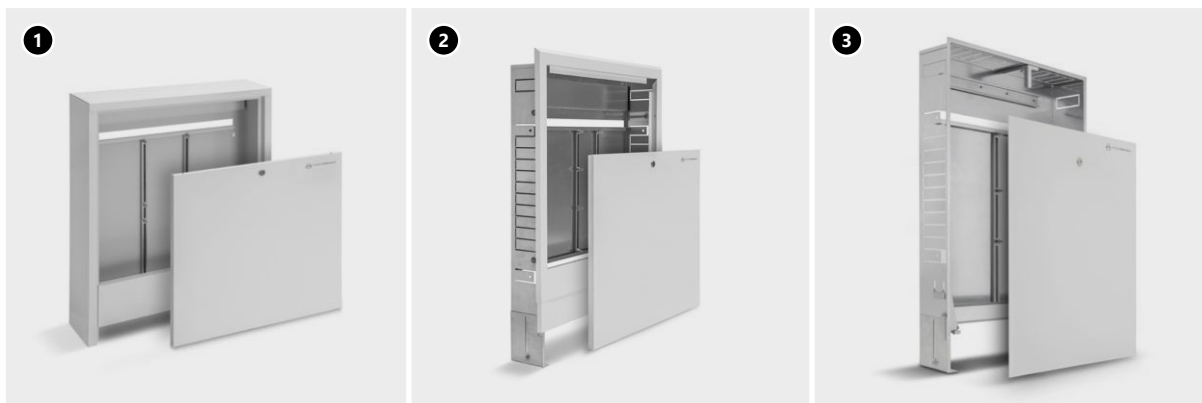
1. glandless electronic pump Wilo PARA 25/6
2. dial thermometers – supply
3. dial thermometers – return
4. return from the mixing unit with G1" male thread
5. G1" × G3/4" union connectors
6. G1" male union connectors for manifold attachment
7. 3-way mixing thermostatic valve Afriso ATM 363 or ATM 561 with G1" male connections.

Construction, mounting, start-up and operation of individual mixing systems versions are included in the manuals. The manuals contain charts with pump and ZR control valve properties.



## 4.10 Installation cabinets

Manifolds for surface heating or cooling can be mounted in special installation cabinets, available in three versions: surface mounted, recess mounted and frameless recess mounted Slim+.



Due to their design, cabinets for surface heating or cooling manifolds can be mounted with or without a mixing group. In cabinets there is also space for electrical terminal blocks. Depending on the type of the cabinet, terminal blocks can be attached by screws to the special rail through the holes or assembled to the standard DIN rail. Both rails, depending on the installation cabinet type, are placed in the upper part of the design.

Tab. 1. Dimensions and selection of cabinets based on the type of manifold, basic accessories and the method of connection

Cabinet type	Code	InoxFlow Manifold					
		STD	KPL	OPT	+GP H	KPL +GP 3D	OPT +GP 3D
<b>SWN-OP 10/3</b>	1446180000	9	5	7	-	4	4
<b>SWN-OP 13/7</b>	1446180001	13	9	11	5	8	8
<b>SWN-OP 15/10</b>	1446180002	13	12	12	8	11	11
<b>SWP-OP 10/3</b>	1446117003	9	5	7	-	4	4
<b>SWP-OP 13/7</b>	1446117004	13	9	11	5	8	8
<b>SWP-OP 15/10</b>	1446117005	13	12	12	8	11	11
<b>Slim+ 450</b>	1414183018	7	2	5	-	2	-
<b>Slim+ 550</b>	1414183019	9	4	7	-	4	3
<b>Slim+ 700</b>	1414183020	12	7	10	4	7	7
<b>Slim+ 850</b>	1414183021	13	10	12	7	10	10
<b>Slim+ 1000</b>	1414183022	13	13	12	10	12	12
<b>Slim+ 1200</b>	1414183023	13	13	12	13	12	12

**STD** - Manifold without additional accessories, closed from one side with stop end 1".

**KPL** - Manifold with SET-K valves and air vent and drain valve on bar R5541.

**+GP H** - Manifold with integrated constant value mixing unit.

**KPL +GP 3D** - Manifold with air vent and drain valve on bar and connected pump mixing group with three-way thermostatic valve.

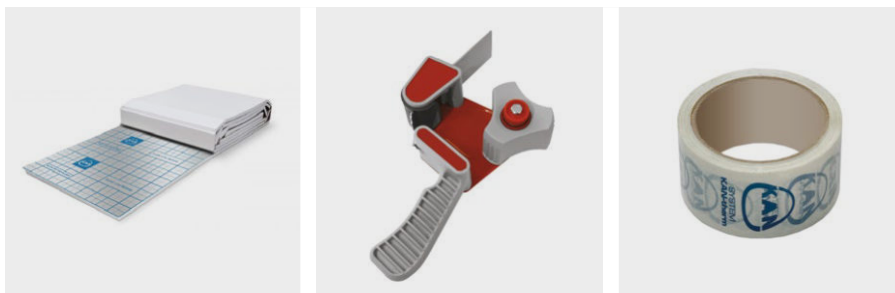
**OPT** - Manifold with integrated air vent and drain group and SET-K valves.

**OPT +GP 3D** - Manifold with integrated air vent and drain group and connected pump mixing group with three-way thermostatic valve.

## 4.11 Design of floor heaters - pipe fastening system

### KAN-therm Tacker system

System KAN-therm delivers insulation panels with a metalized or laminated foil with an overprint every 5 cm.



Use panels Tacker EPS 100 038 (PS20) for standard floor slab loads up to 30 kN/m<sup>2</sup> in residential or office buildings. The foil glued onto plates serves as a damp proof insulation to DIN 18560 and can be overlapped, thus panels can be laid tight. To seal places, where plates join, use adhesive tape dispensed from a hand feeder.



Pipes are fixed to Tacker panels with clips driven with a Tacker tool. For 20 mm thick styrofoam panels use short clips driven with a Tacker tool for short clips. Thanks to an overprinted grid it is easy to lay pipes at a determined spacing. You can use Ø14×2, 16×2, 16×2,2, 18×2, 20×2, 20×2,8 mm pipes spaced every 10-30 cm.

Pipes can be fastened to styrofoam sheets of the Tacker type also using mounting rails or with NET nets with clamps (see: system KAN-therm Rail and NET).

When laying Tacker panels with a foil follow requirements from the EN 1264 standard regarding the minimum heat resistance of a floor-ceiling assembly with the floor heating. In case of floors on the ground and floor slabs in contact with atmospheric air under the EPS system plates there should be an additional insulation. For requirements and versions of using multilayer system plates type EPS with an additional foil see Table 2.

Tab. 2. KAN-therm Tacker system – Minimum requirements for insulation according to EN 1264 standard

Required insulation thickness above a heated room $R=0,75$ [m <sup>2</sup> K/W] (PN-EN 1264)			
Floor heating system	Additional insulation	Insulation resistance R [m <sup>2</sup> K/W]	Insulation thickness [mm]
Tacker system 30 mm	-	0,79	30
Tacker system 20 mm	foamed polystyrene EPS100 (PS20) 20 mm	1,06	40
Required insulation thickness above an unheated room or on the ground ( $T_z \geq 0$ °C) $R=1,25$ [m <sup>2</sup> K/W] (PN-EN 1264)			
Tacker system 30 mm	foamed polystyrene EPS100 (PS20) 20 mm	1,32	50
Tacker system 20 mm	foamed polystyrene EPS100 (PS20) 40 mm	1,38	60
Required insulation thickness in case of the contact with air ( $-5$ °C $\geq T_z \geq -15$ °C) $R=2,00$ [m <sup>2</sup> K/W] (PN-EN 1264)			
Tacker system 30 mm	foamed polystyrene EPS100 (PS20) 50 mm	2,00	80
Tacker system 20 mm	foamed polystyrene EPS100 (PS20) 70 mm	2,13	90

## KAN-therm Profil system

KAN-therm system provides Profil system panels, where pipes are attached by inserting into the shaped top part of the panel. You can use PEXC, PERT, PERT<sup>2</sup>, bluePERT pipes with EVOH layer or PERTAL, PERTAL<sup>2</sup> and bluePERTAL pipes with aluminium layer with diameters of 16 × 2, 16 × 2,2, 17 × 2 and 18 × 2.



Profil foamed polystyrene boards:

- **Profil1** - 30 mm - polystyrene foamed panels with PS foil with thickness of 30 mm and dimensions 0,8 × 1,4 m. Panel height with profiled part is 51 mm, and permissible load is 5,0 kN/m<sup>2</sup>. Profil1 panel fulfils the requirements for ceilings between heated spaces R=0,75 m<sup>2</sup>/k/W.
- **Profil2** - 11 mm - polystyrene foamed panels with PS foil with thickness of 11 mm and dimensions 0,8 × 1,4 m. Panel height with profiled part is 32 mm, and permissible load is 60 kN/m<sup>2</sup>.
- **Profil3** - PS foil without foamed polystyrene panel with thickness 1 mm and dimensions 0,8 × 1,4 m. PS panel height with profiled part is 20 mm.
- **Profil4** - 20 mm - polystyrene foamed panels without PS foil with thickness of 20 mm and dimensions 1,2 × 0,6 m. PS panel height with profiled part is 43 mm. Permissible load is 20 kN/m<sup>2</sup>.

When laying Profil1, Profil2 and Profil4 panels apply EN 1264 standard regarding minimum thermal resistance of floor with underfloor heating. Requirements and application variants of Profil panels are given in Tab. 3.

Tab. 3. KAN-therm Profil system - minimum requirements for insulation according to EN 1264 standard

Required insulation thickness above a heated room R=0,75 [m <sup>2</sup> K/W] (PN-EN 1264)			
Underfloor heating system	Additional insulation	Insulation resistance R [m <sup>2</sup> K/W]	Insulation thickness [mm]
<b>Profil1 system 30 mm</b>	-	0,75	30
<b>Profil2 system 11 mm</b>	foamed polystyrene EPS100 (PS20) 20 mm	0,84	31
<b>Profil4 system 20 mm</b>	foamed polystyrene EPS200 (PS20) 20 mm	1,09	40
Required insulation thickness above an unheated room or on the ground (T <sub>z</sub> ≥ 0°C) R=1,25 [m <sup>2</sup> K/W] (PN-EN 1264)			
<b>Profil1 system 30 mm</b>	foamed polystyrene EPS100 (PS20) 20 mm	1,28	50
<b>Profil2 system 11 mm</b>	foamed polystyrene EPS100 (PS20) 40 mm	1,36	51
<b>Profil4 system 20 mm</b>	foamed polystyrene EPS200 (PS20) 30 mm	1,35	50
Required insulation thickness in case of the contact with air (-5°C ≥ T <sub>z</sub> ≥ -15°C) R=2,00 [m <sup>2</sup> K/W] (PN-EN 1264)			
<b>Profil1 system 30 mm</b>	foamed polystyrene EPS100 (PS20) 50 mm	2,07	80
<b>Profil2 system 11 mm</b>	foamed polystyrene EPS100 (PS20) 70 mm	2,15	81
<b>Profil4 system 20 mm</b>	foamed polystyrene EPS200 (PS20) 60 mm	2,14	80

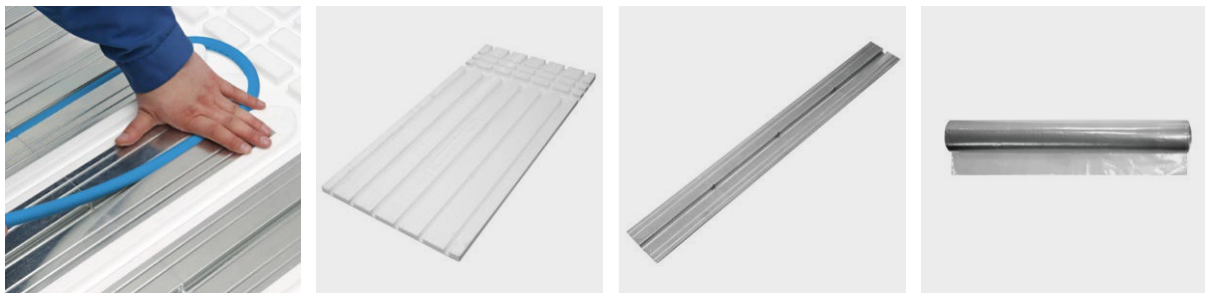
## KAN-therm TBS system

KAN-therm TBS system underfloor heating is made using "dry" method, i.e. after laying the underfloor heating system, it is covered with dry „jointless" floor (special floor panels).

Assembly of the system of pipe laying can take place only on totally dry and leveled floor surfaces. After laying TBS boards and pipes the system is covered with PE foil for protection and to avoid possible sounds of structure thermal movements.

Next, covering board of jointless floor 25-45 mm thick is laid. All information on covering boards (permitted loads) should be obtained from the producer of covering boards.

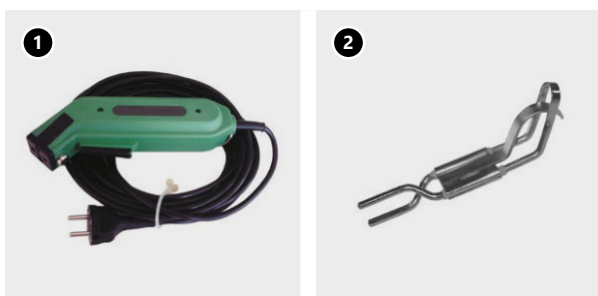
KAN-therm TBS system includes:



- insulation board, insulation profiled board TBS 25 mm EPS150 (PS30) with dimensions 0,5×1,0 m;
- complementary insulation board, TBS 25 mm EPS150 (PS30) with dimensions 0,5×1,0 m,
- straight TBS metal profile with dimensions 1,0×0,12 m;
- PE foil in rolls.

KAN-therm TBS system allows to lay PERTAL, PERTAL<sup>2</sup> and bluePERTAL pipes with aluminium layer or bluePERT pipes with EVOH layer of diameters Ø16×2 and 16×2,2 mm with 167 - 250 - 333 mm spacing. Because of pipe thermal expansion, straight pipe section should not be longer than 10 m. Metal profile is pushed in laid roll formed TBS boards and then pipe is pushed in such a way that it is inside the metal profile. The metal profile has lateral incisions, which facilitates easy adjustment of its length by breaking, every 250 mm. The edge of the metal profile should end approx. 50 mm before the beginning of pipes direction change (avoiding friction of pipes against the profile as a result of thermal expansion). When laying roll formed TBS boards take into consideration planned coil shape; meander shape is recommended.

Complementary insulation TBS board is used in situations when basic boards profile precludes pipes from accessing the manifold (pipe density). In such situations a required profile is cut out by a TBS cutter in complementary board.



1. TBS insulation cutter
2. TBS cutter tip

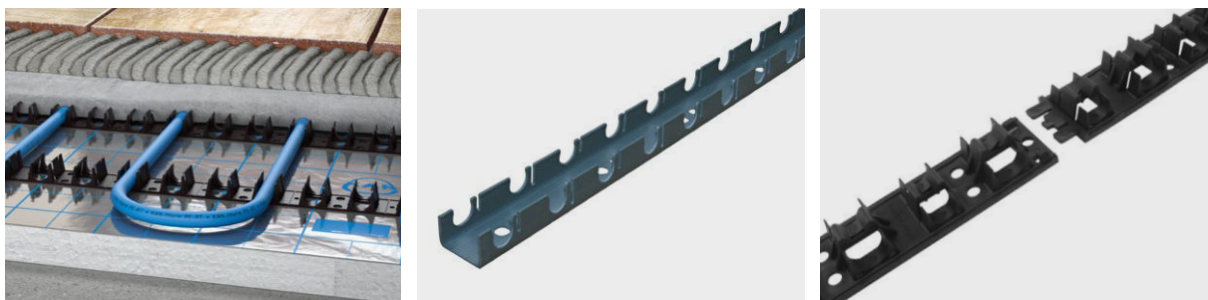
When laying TBS boards comply with requirements of EN 1264 regarding minimum thermal resistance of floor with underfloor heating. Requirements and variants of TBS boards application are given in Table 4.

Tab. 4. KAN-therm TBS system - minimum requirements for insulation according to EN 1264 standard

Required insulation thickness above a heated room $R=0,75$ [ $m^2K/W$ ] (PN-EN 1264)			
Underfloor heating system	Additional insulation	Insulation resistance R [ $m^2K/W$ ]	Insulation thickness [mm]
TBS system 25 mm	foamed polystyrene EPS150 (PS20) 20 mm	1,21	45
Required insulation thickness above an unheated room or on the ground ( $T_z \geq 0^\circ C$ ) $R=1,25$ [ $m^2K/W$ ] (PN-EN 1264)			
TBS system 25 mm	foamed polystyrene EPS150 (PS20) 30 mm	1,46	55
Required insulation thickness in case of the contact with air ( $-5^\circ C \geq T_z \geq -15^\circ C$ ) $R=2,00$ [ $m^2K/W$ ] (PN-EN 1264)			
TBS system 25 mm	foamed polystyrene EPS150 (PS20) 60 mm	2,21	85

## KAN-therm Rail system

An essential element of KAN-therm Rail system are special plastic mounting rails for pipe attachment. You can use PEXC, PERT, PERT<sup>2</sup>, bluePERT, PERTAL, PERTAL<sup>2</sup> and bluePERTAL pipes with diameters Ø12, Ø14, Ø16, Ø18, Ø20, Ø25, Ø26 mm. The pipes can be laid with 10-30 cm distance - with spacing of 5 cm or 10 cm (depending on the type of the rail).



## KAN-therm NET system

KAN-therm NET system is a system of pipe laying on wire nets, available in the following assortment:

- PE foil 2,0 m×50 m×0,8 mm,
- 3 mm wire net 1,2 m×2,1 m and mesh spacing 150×150 mm,
- fastening bands for tying nets,
- PE fastening peg 80 mm - Ø8 mm for foil fastening,
- pipe fastening grips Ø16-18 mm and Ø20mm.

On thermal insulation made of EPS 100 038 boards or EPS 200 036 moisture insulation made of PE foil is laid and then wire nets. On wire nets with given spacing pipe grips are mounted (on the wire or crossing of wires) in which pipes are pushed. Spacing between pipe and insulation layer is 17 mm.

KAN-therm NET system can be successfully applied in order to fasten pipes to Tacker foamed polystyrene boards with metalized foil or laminated foil. In such cases do not use additional foil.



## 4.12 Execution of floor screed

Prepared floor heating or cooling systems should be covered with a layer of concrete or anhydrite screed. In the case of anhydrite screeds must comply with its manufacturer's / supplier.

### **When making underfloor heating systems, observe the following guidelines:**

- while laying screed keep pipes under pressure at least 3 bar (recommended 6 bar),
- pipes should be protected from mechanical damage during construction work,
- determine passageways for example by using boards,
- screed needs to be nurtured,
- cement screed bonding period is 21-28 days, only after this period, you can run the heating,
- Installation start is carried out with an initial water temperature of 20 °C, temperature should be raised about 5 °C each day until its value reaches designed level,
- after start-up periods screed should be basked min for 4 days with a maximum (designed) temperature to remove excess moisture,
- floor coverings should be laid at a temperature of 18-20 °C of the floor, after screed is basked,
- pay attention to the proper implementation of joint of ceramic tiles (they should coincide with dilatation),
- adhesives should be permanently flexible at 55 °C (hold manufacturers certificates for use in underfloor heating).

### **Requirements for concrete slab:**

- minimum layer thickness over the pipe: 4,5 cm (6,5 cm thick over the thermal insulation),
- using concrete plasticizer BETOKAN Plus you can reduce the thickness of concrete slab above the pipe to 2,5 cm (4,5 cm thick over the thermal insulation),
- large casted areas should be divided into smaller with dilatation tape (with minimum thickness of 0,5 cm) so that the length of homogeneous plates do not exceed 8 m, the whole area of 30 m, and the ratio of the length of its width is 1:2,
- in case of ceramic tiles and ceilings carrying heavy loads, we recommended reinforcement by placing over the pipes fibreglass mesh with a mesh of 40×40 mm. Using reinforcement is not essential, however, the strength of the floor in the event of a crack is reduced in the height and width. Mesh must be stopped in the dilatation points. For floors carrying heavy loads (more than for residential buildings) such type of insulation and concrete slab height should be selected, so that the deflection does not exceed 5 mm,
- use B20 concrete class with the addition of a new plasticizer BETOKAN or BETOKAN Plus,
- concrete slab as a result of thermal work can not create pressure for structural elements of buildings (use dilatation joints).

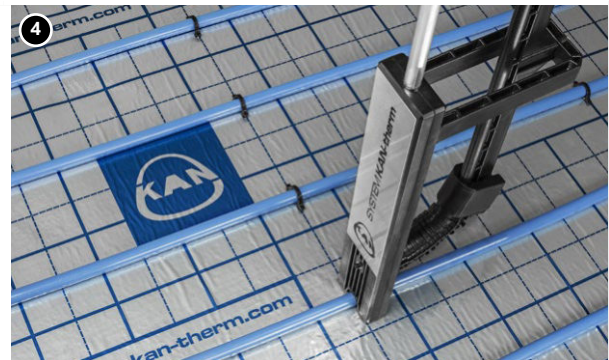
### **The composition of cement to aggregate ratio is 1:4,5 parts by weight:**

- 50 kg cement CEMI (DIN 1164),
- 225 kg of aggregate (60% sand with a grain size up to 4 mm and 40% gravel with a grain size of 4 - 8 mm), in case of use of BETOKAN plasticizer:
  - 16 – 18 l of water,
  - 0,2 kg of BETOKAN,
  - Use 0,25 - 0,6% related to the cement mass (on average 200 ml for 50 kg of cement), together with batched water and aggregate. In hot weather it is recommended to double this dose to extend concrete workability.
- in case of use BETOKAN Plus plasticizer:
  - 8 – 10 l of water,
  - 5 kg of BETOKAN Plus,
  - average consumption rate is: 10 kg per 7,5 m<sup>2</sup> of screed, at slab thickness 4,5 cm, which is 30 to 35 kg per 1 m<sup>3</sup> of concrete.

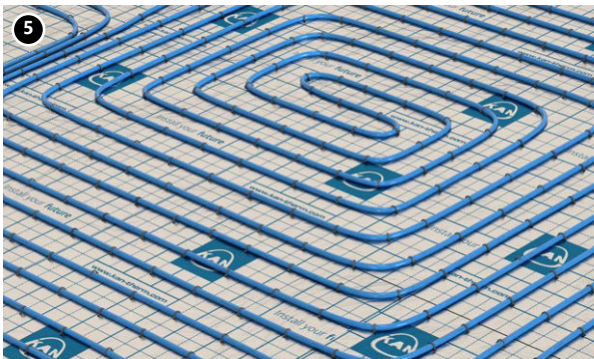
## 4.13 Assembly



1. Deploy the wall edge tape
2. Spread the styrofoam with PE-foil on top of it.



3. Contact points of all edges must be sealed with an adhesive tape as the laying of subsequent strips progresses.
4. Proceed to the laying of heating pipes on the insulation, starting from the manifold.



5. Perform a pressure test of arranged coils leakage in accordance with the rules applicable for the surface heating (see section Acceptance forms). After the test, leave the pipes under pressure (min 3 bars).

For detailed information on the assembly of system KAN-therm floor heating and on the start-up of the system see: "Laying the system KAN-therm by the Wet Method".

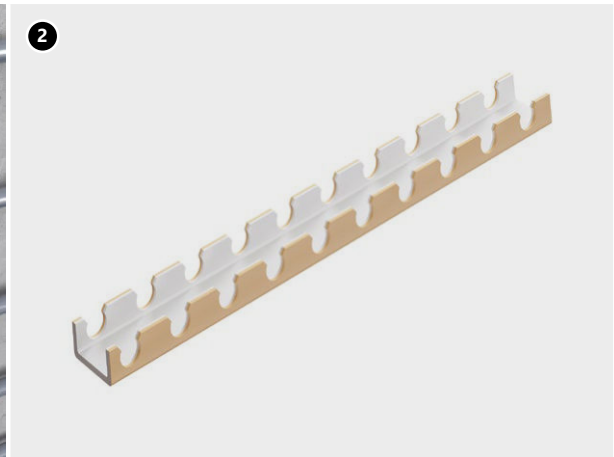
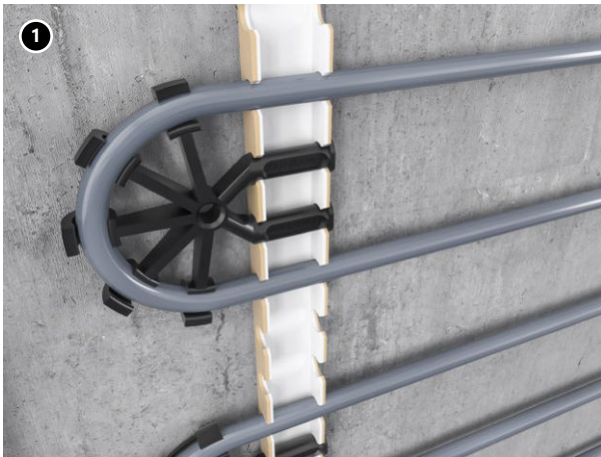
## 4.14 Construction of wall heaters/coolers - pipe fastening systems

### Wet method

KAN-therm wall heating/cooling elements are ideal for the construction of various types of heating and cooling systems mounted on the vertical construction partitions. Having all the advantages of surface heating/cooling, KAN-therm hydronic wall heating/cooling is further characterized by the following beneficial features:

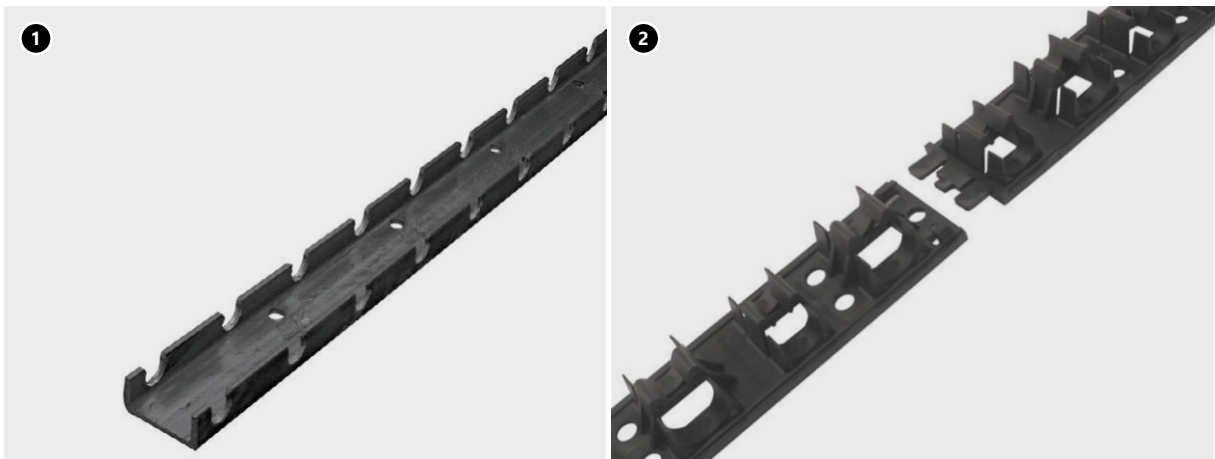
- may function as the only independent room heating, or serve as a supplementary heating in the absence of sufficient space for underfloor heating in the room. It may also support the radiator heating, while increasing the comfort in the rooms (used for the modernization of the heated building),
- it ensures uniform, almost ideal temperature distribution in the room and as a result high thermal comfort.
- vertical partitions, due to the identical heat transfer coefficients both for heating and cooling, are ideal for dual systems (heating/cooling).
- heat transfer takes place primarily through favourable radiation (approx. 90%),
- the temperature of the heating surface may be higher than in the underfloor heating (35 °C) resulting in a higher heat efficiency,
- approximate heat output 120-160 W/m<sup>2</sup> (provided the maximum wall temperature is not exceeded).
- due to the smaller thickness of the heating / cooling panel and a small (or zero) thermal resistance of the outer layers (cladding) of the walls, the thermal inertia is lower and the temperature adjustment becomes easier.

The main feature are special rail plastic strips for fastening pipes. You can use the following pipes: PB, PEXC, PERT, PERT<sup>2</sup>, bluePERT, PERTAL, PERTAL<sup>2</sup> and bluePERTAL with the diameter Ø8, Ø12, Ø14, Ø16 mm. Pipes may be laid with a distance of 6-30 cm - in steps of 6 cm (diameter 8 × 1 mm) or 10-30 cm - with step of 5 cm for the remaining diameters.



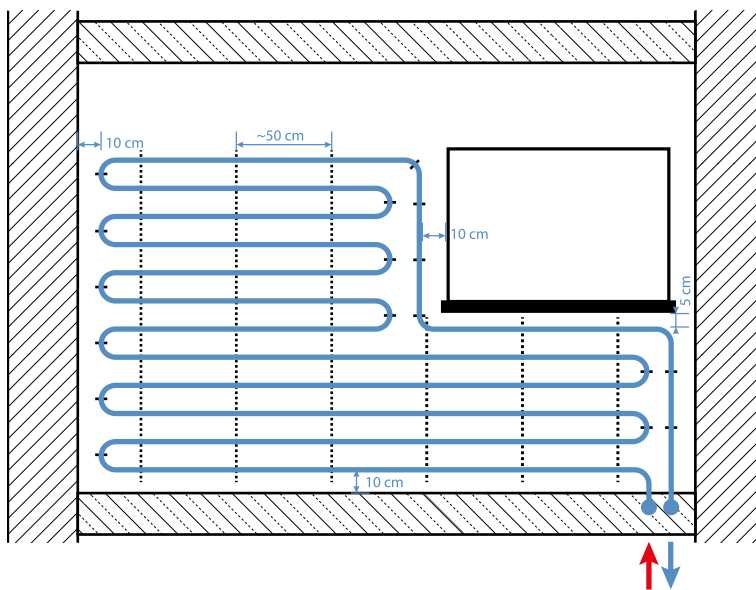
1. Profiling curve D60 mm for pipes of Ø8 mm.
2. Mounting rail for pipes of Ø8 mm.





1. Mounting rail.
2. Modular mounting rail.

Wall heating/cooling is mounted on the external walls with a thermal transmittance coefficient of  $U \leq 0,35 \text{ W/m}^2 \times \text{K}$ . If the coefficient exceeds  $0,4 \text{ W/m}^2 \times \text{K}$ , the wall must be additionally insulated. It is recommended that installation be done near window openings, e.g. under the window sills. Heating/cooling may also be laid in the inner walls. You should use KAN-therm system pipes PB with the diameter of  $8 \times 1$ , KAN-therm system pipes PEXC, PERT, PERT<sup>2</sup> or bluePERT with the diameter of  $12 \times 2$ ,  $14 \times 2$ ,  $16 \times 2$ ,  $16 \times 2,2$  and KAN-therm system pipes with aluminium layer PERTAL, PERTAL<sup>2</sup> or bluePERTAL with the diameter of  $14 \times 2$ ,  $16 \times 2$  or  $16 \times 2,2$ . Recommended spacing between the pipes is 25 cm. Pipes should be installed with a meander pattern. In case of small spacing, pipes may be installed with a double meander pattern. The heating surfaces should be kept clear of furniture, paintings, curtains. Before laying the surface heaters/coolers you should first complete all installation and electrical works. The minimum distances between the heating/cooling pipes and the adjacent partitions and holes are presented in the following figure.



Mounting distances in wall heating/cooling

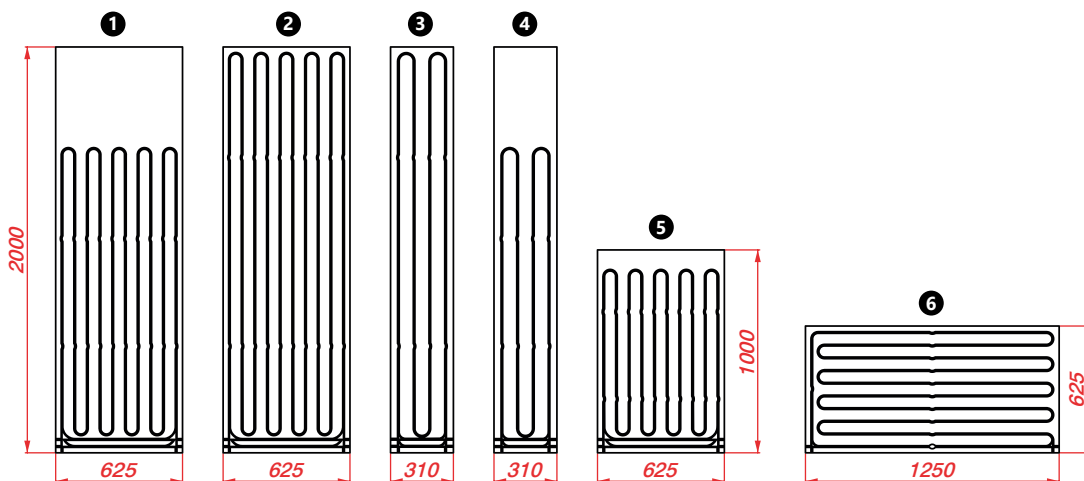
The contact points between the heating/cooling walls and adjacent partitions should be fitted with expansion joints. Loop supply pipes laid on the floor should be provided with insulation or protective tube. At the transition from the floor to the wall the pipe should be laid with a 90° guide. The heating/cooling loops are supplied by KAN-therm manifolds for surface heating/cooling. The loops may also be supplied with counter-current Tichelmann system, provided the length of each connected circuit is identical. To determine the position of the heating/cooling pipes in the existing wall systems you may use a thermal imaging camera or a special heat-sensitive film.

## Installation of wall heating/cooling using wet method

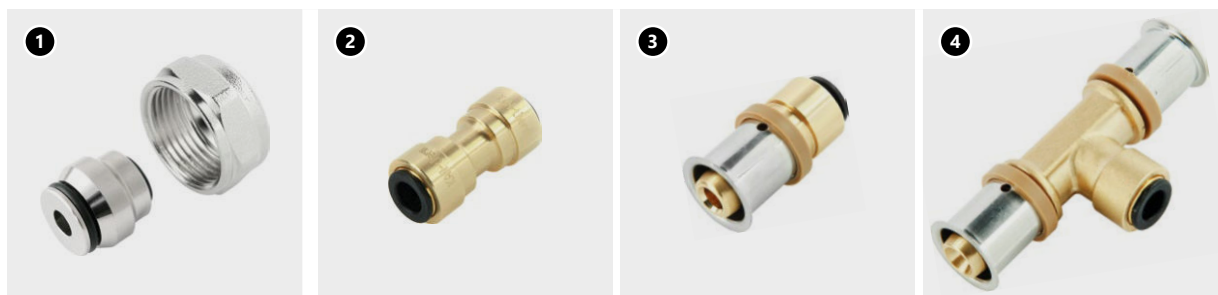
Pipes should be mounted with KAN-therm Rail mounting rails which are fixed to the wall using dowels. The spacing between the mounting rails should not exceed 50 cm. The plaster layer of the heating/cooling wall should have good thermal conductivity (min. 0,37 W/m × K), resistance to temperature (approx. 70 °C for cement-lime plasters, 50 °C for gypsum plasters), flexibility and low expansion coefficient. The type of plaster must be suitable for the room concerned. You may use cement-lime plasters, gypsum plasters, as well as clay mortars. Recommended finished plasters: e.g. KNAUF MP-75 G/F. The air temperature during plastering works should not be lower than 5 °C. The plaster should be applied in steps: first layer with a thickness of approx. 20 mm should completely cover the heating/cooling pipes. The fresh layer must be covered with fibreglass mesh of 40 × 40 mm, then apply the second layer with a thickness of 10 – 15 mm. The mesh strips should overlap each other and those of adjacent surfaces (approx. 10 – 20 cm). The maximum height of the heating field is 2 m. The surface of the field should not exceed 6 m<sup>2</sup>/heating/cooling circuit. During plastering the heating/cooling pipes should be filled with water under pressure (min. 1,5 bar). The heating-up stage should be started only after the plaster has dried (the time specified by the manufacturer of plaster - from 7 days for gypsum plasters, up to 21 days for cement plasters). The plaster may be covered with paints, wallpaper, structural paints and ceramic tiles.

## Dry method

The main feature are gypsum fibre WALL boards with embedded polybutylene heating pipe Ø8×1 mm. The boards are available in wide selection of dimensions, with coil spacing of 6,25 and 7,75 cm. The thickness of the board is 15 mm.



The boards are mounted on the external walls with a thermal transmittance coefficient of  $U \leq 0,35 \text{ W/m}^2 \times \text{K}$ . If the coefficient exceeds  $0,4 \text{ W/m}^2 \times \text{K}$ , the wall must be additionally insulated. Heating/cooling may also be laid in the inner walls. You should use polyurethane adhesives or appropriate screws / mounting dowels. The pipes may be connected in series or with counter-current Tichelmann system using pipes with aluminium layer of  $\text{Ø}16 \times 2 \text{ mm}$ . This is done using special sections for toolless connection. You should not exceed the total length of a single loop 80 m.



1. Union for pipes 8×1 G $\frac{3}{4}$ ".
2. Click joint for pipes 8×1.
3. Reduction joint Press-Click 16 / 8
4. Tee with an off-take Press-Click-Press 16 / 8 / 16.

## 4.15 Automatic control of heating/cooling systems

Presently the automatic control even the most simple one counts as an indispensable element of heating/cooling systems (mounted in single family houses, blocks of apartments, public houses and industrial buildings) and as well of all types of external surface heating.

Diversity of technical solutions for the heating technology and in first line solutions of very commonly used mixed heating systems, e.g. a surface heating combined with a conventional radiator heating, despite many advantages, without proper control elements, can lead to a substantial discomfort. Usually overheating, underheating or not a uniform temperature in individual spaces causes this discomfort.

Without a correctly configured automatic control controlling individual heating systems can cause significant heat losses (overheated rooms), therefore an increase in the operation cost of a heating system.

KAN-therm system offer of surface heating/cooling automatic control allows to optimise a heating/cooling system depending on local requirements by selection of appropriate devices, elements etc.

Automation components for radiant heating/cooling KAN-therm system come in two versions:

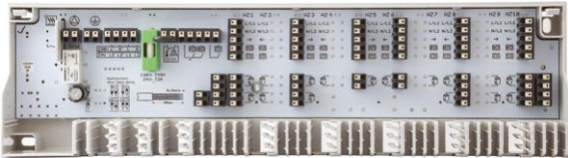
- terminal blocks and thermostats – version Basic+,
- terminal blocks with LAN module, room thermostats and servomotors SMART.



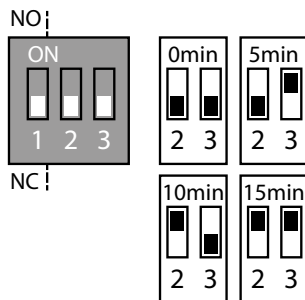
## Basic+ automation



**Basic+ automation** - a set of devices for wired, precise temperature control in rooms. Basic+ is the ideal solution for both simple and complex heating or cooling systems. Its modern design perfectly blends with the various interior arrangements.



**Basic+ terminal blocks** provide power for all control elements. Available with heating - cooling version with possibility to control 6 or 10 heating zones. Both versions are available in 230V and 24V version (required 230/24 V AC transformer). Terminal blocks can control the boiler and circulation pump operation. In addition the automatic mode can be set to work with Normally Closed or Normally Open devices.



The operation mode setting is carried out using Jumper 1:

**NO mode:** Jumper 1 = ON

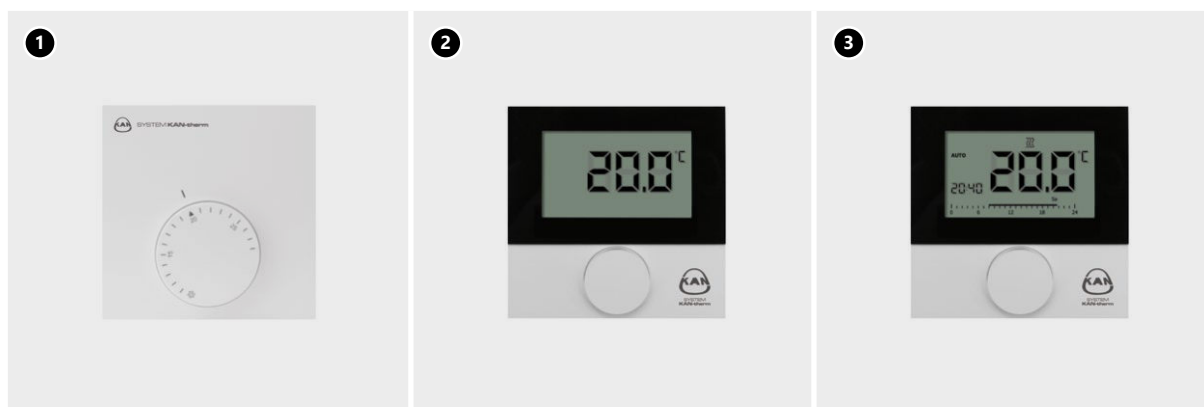
**NC mode:** Jumper 1 = OFF

The constant overtravel time of the pump or boiler of 2 min may be increased by a further 5, 10 or 15 minutes using Jumper 2 and 3.

Additional time	Jumper 2	Jumper 3
0 min	OFF	OFF
5 min	OFF	ON
10 min	ON	OFF
15 min	ON	ON

Terminal block Basic+	24V	230V
Ground connector		+
Pump / boiler power outlets (230 V)		+
Dew point sensor connector (24 V)	+	
Selectable pump / boiler switch delay	+	+
Direct operation pump module		+
Temperature limiter connector	+	+
External timer connection	+	+
Heating / cooling change over (CO)	+	+
Pump or boiler type (NC or NO)	selectable	selectable
LED indicators	+	+
Number of heating zones	6 or 10	6 or 10

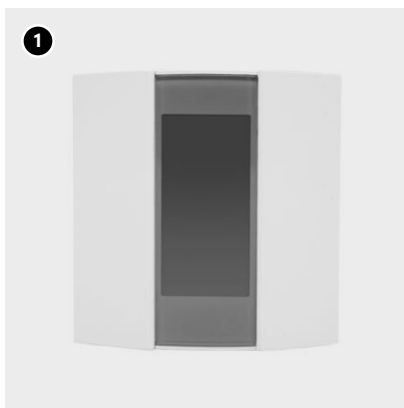
## Basic+ thermostats



1. Analogue room thermostat.
2. Room thermostat with LCD Standard.
3. Room thermostat with LCD Control.

Funktionalität	Analogue room thermostat		Thermostat with LCD	
	Heating 1802265024 1802265025	Heating /Cooling 1802265032 1802265033	Standard 1802265020 1802265021	Control 1802012005 1802012004
Operation in heating systems	+	+	+	+
Operation in cooling systems		+		+
NC and NO servomotors operation				+
Constant value night temperature setback	+	+	+	
Variable temperature set-point for both: heating and cooling operation				+
User comfort programs				+
Variable mode: Day / Night / Auto			+	+
Temperature reduction signal input	+	+	+	
Temperature reduction signal output				+
Internal timer				+
Voltage sustain				+
Change Over (CO) connector (heating / cooling)		+		+
Temperature measurement correction			+	+
Temperature settings limiter	+	+	+	+
Valve protection function		+	+	+
Protection against system freezing	+	+	+	+
Lock against operation in heating or cooling mode				+
Smart Start / Smart Stop function				+
Floor temperature sensor connector				+

## Basic+ weekly room thermostats



1. Weekly programmable room thermostat with floor temperature sensor 230V - allows for individual temperature regulation. Room thermostat is equipped with 7 day programming feature and floor temperature sensor. Possible manual, automatic and floor temperature mode. Assembly inside an electrical box.

## Additional elements Basic+



1. 230V - 24V power converter for Basic/Basic+ terminal block  
2. M30 × 1,5 Adapter for the electric servomotor (gray) - used for valves on the lower beam of InoxFlow UVS, UVST, UFS or UFST series or on upper beam of InoxFlow manifold with integrated mixing groups - USVP or USFP series.  
3. M28 × 1,5 Adapter for the electric servomotor (gray) - used for valves on the upper beam of 71A, 75A, 73A, 73E, 77A, 77E manifolds series.



4. KAN-therm servomotor - 230 V or 24 V version "First Open" function for easy installation of the servomotor and pressure test. NO or NC operating mode versions. Quick installation with KAN-therm M30x1,5 adapters. Solid mounting with three-point locking system. Servomotor calibration - automatic alignment to the valve. Visualization of the servomotor operating status. Servomotor assembly in any position. 100% protection against water and moisture. Energy efficiency - power consumption of only 1W.

## SMART automation

### Smart and intelligent - new KAN-therm Smart wireless automation system

A comfortable and energy efficient home is the goal and the dream of today's families planning to build or modernize their houses and apartments. The method of heating/cooling is one of the most important factors determining the operating costs and the sense of security and comfort of use. Surface heating/cooling (floor or wall) is the optimal solution that assures meeting such requirements. However, like any heating/cooling system, it requires a proper control system. Precise devices regulating the temperature in the room provide an adequate thermal comfort and on the other hand allow for significant energy savings. The regulation can be done manually or in the automatic mode, with the use of the appropriate sensors, regulators and servomotors.

The requirements of the users are constantly increasing. They are expecting not only the reliability and effective operation of these devices but also hassle-free, easy operation and the possibility of varied configuration, including remote configuration using mobile devices such as a laptop or a smartphone. The attractive aesthetics of these devices and the possibility to expand the system in the future are also of great significance.

KAN-therm radiant heating and cooling offer includes a wide range of modern solutions like controlling devices and automatic regulation of the temperature. This also includes technologically advanced wireless devices communicating through the radio waves, greatly simplifying installation of the heating/cooling system controls and eliminating the problems and costs associated with distributing many meters of wires in the building. They are virtually indispensable in the case of retrofitting existing modernized installations with automatics.



Devices of the KAN-therm Smart system are a completely new generation in this group of automation elements, offering unprecedented operating and handling possibilities. They are used for the wireless control and regulation of temperature and other parameters of the heating and cooling systems, which determine the sense of comfort in the rooms. The system also provides a number of additional advanced features, which make the operation and handling of the heating/cooling system very effective, energy efficient and user-friendly.

Basic component and the heart of KAN-therm Smart system is the modern wireless terminal block with an LAN connection. Using radio communication (868 MHz, two-way transmission) it communicates with the wireless, elegant thermostats with LCD display, which function both as temperature sensors in the rooms and are also displaying and transmitting a number of settings and information controlling the entire system. This information is transmitted, through the terminal block, to the executive elements - modern,

energy-efficient KAN-therm Smart servomotors located on the valves of the manifolds of the heating (or cooling) circuits. The terminal blocks and servomotors are available in the 230 and 24V power supply options. Depending on the used version, the terminal block can operate 4, 8 or 12 thermostats controlling respectively 6, 12 or 18 servomotors.

The KAN-therm Smart system is a multi-functional system which in addition to controlling and regulating the temperature in various heating zones, also realizes the switching between heating / cooling modes, the control of the heat source and operation of the pump as well as control of humidity in the cooling mode. The terminal blocks also enable connecting a temperature limiter and an external control timer. Functions such as protection of the pump and valves (activated after periods of extended downtime) and protection from frost and excessive critical temperature are also realized.

Measure of the system's high technological advancement is the method of installation and configuration. These operations can be done in several ways:

- Configuration using a microSD card. Using the computer and the intuitive KAN-therm Manager program we can determine individual configuration settings, which are then transferred using a microSD card to the terminal block equipped with a card reader.
- Remote configuration of the terminal block connected directly to the Internet or the local network through the KAN-therm Manager software interface.
- Direct configuration thanks to KAN-therm Smart thermostat (with the use of the LCD display).

In any case, the configuration and operation of the system is user friendly. Many processes take place automatically and the settings both with thermostat or the KAN-therm Manager program are very intuitive. The expansion of the system and a quick update of the terminal block settings does not cause any trouble either.

Thanks to the radio technique, in the case of bigger installations, with the use of 2 or 3 KAN-therm Smart terminal blocks, it is possible to combine them into one system enabling mutual communication.





## KAN-therm Smart wireless terminal blocks with LAN connection



- Two-way 868 MHz wireless technology,
- 230V or 24V (with a power converter),
- The possibility of connecting up to 12 thermostats and up to 18 servomotors,
- Heating and cooling modes as a standard,
- Pump protection and manifold valves protection functions, frost protection function, safety temperature limiter, emergency mode,
- Operating modes of the servomotors: NC (normally closed) or NO (normally open),
- MicroSD card reader,
- RJ 45 Ethernet socket (for connecting to the Internet),
- The ability to connect additional devices: pump module, dew point sensor, external timer, additional heat source controller,
- Clear visualization of the operating status with LED indicators,
- 25 m range inside buildings,
- Start „SMART“ function – the ability to run an automatic adjustment of the system to the conditions in the room / building,
- Configuration using a microSD card, through the software interface of the network version or by the wireless thermostat,
- The possibility of easy and simple expansion of the system and quick updating of settings (through the network or the microSD card).

## Wireless LCD thermostat KAN-therm Smart



- Modern and elegant design, high quality scratch-resistant material,
- Small size of the device 85 x 85 x 22 mm,
- Large (60 × 40 mm) clear LCD display with a backlight,
- Communication system based on pictograms and a rotary knob ensure intuitive and easy operation,
- Very low energy consumption - over two years battery lifetime,
- Possibility of connecting a floor temperature sensor,
- Two-way radio data transmission within a range of 25 m,
- Comfortable and safe use guaranteed by a three-level MENU layout: user functions, parameters of user settings, installer settings (service),
- Many useful features such as: child safety lock, standby mode, modes of operation day / night or auto, „Party“, „Vacation“ features,
- A number of possible parameter settings - temperature (heating / cooling, temperature drop), timer, programs.

## KAN-therm Smart Servomotors



- 230 V or 24 V Version,
- „First Open“ feature facilitating installation of the servomotor and the performance of the pressure test,
- NC or NO operating mode versions,
- Fast installation with the use of M30×1,5 or M28×1,5 KAN-therm adapters,
- Reliable mounting with a three-point locking system,
- Calibration of the servomotor – automatic adjustment to the valve,
- Visualization of the operating mode of the servomotor,
- Installation of the servomotor in any position,
- 100% protection against water and moisture,
- Energy efficiency - only 1 W power consumption.

## Automation additional elements



1. External surface ice controller with the external temperature and icing sensor - in cooperation with the heating system it protects against icing and snow depositing on stairs, parking lots, driveways, etc.
2. The snow and ice sensor, as well as the external temperature sensor is assembled with a 15 m electric wire.

## Rinsing, tightness tests of KAN-therm installations

After completing, the KAN-therm installation should be pressure tested. It should be done before pouring screed on the pipes. Perform a tightness test with water. If the conditions do not allow conducting a water test (e.g. low temperatures), you may also conduct a compressed air test.


The tightness test should be done after venting the whole heating/cooling system in accordance with the KAN tightness test protocol - see KAN Surface heating and cooling Guidebook.

# Surface heating and cooling in KAN-therm system - assortment

## Wall/ceiling heating and cooling

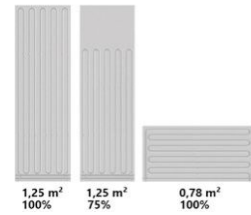
### Wall heating panel with PB 8×1 pipe

GROUP: A

Size [mm]	*	Code		UM
2000×625 (100%)	*	1800188022	1	m <sup>2</sup>
2000×625 (75%)	*	1800188023	1	m <sup>2</sup>
2000×310 (100%)	*	1800188024	1	m <sup>2</sup>
2000×310 (75%)	*	1800188025	1	m <sup>2</sup>
1000×625 (100%)	*	1800188026	1	m <sup>2</sup>
625×1250 (100%)	*	1800188027	1	m <sup>2</sup>

**Note:**

Percentage values indicate usable heating areas.



### Cover panel

GROUP: A

Size [mm]	*	Code		UM
2000×625	*	1800188020	1	m <sup>2</sup>



### Grooved panel

GROUP: A

Size [mm]	*	Code		UM
2000×625	*	1800188021	1	m <sup>2</sup>



### Polyurethane adhesive

GROUP: A

Capacity	*	Code		UM
310 ml		1800183002	1	pc.



### Pilot curve for pipe - 8×1

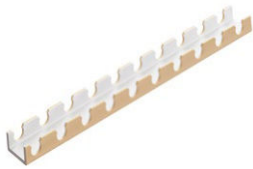
GROUP: A

Size [mm]	*	Code			UM
8×1		1800011000	100	3000	pc.



 coil  bar  pipes in tube  bag  carton box  pallet **N** new  available soon

\* custom-made - lead time max 4 weeks | \*\* availability as agreed | \*\*\* while stock lasts



### Mounting rail for pipe fastening 8×1

GROUP: A

Size [m]	*	Code			UM
2		1800209031	2	100	m



### PB pipe with EVOH layer - coil

GROUP: C

Size [mm]	*	Code			UM
8×1,0		1829197016	600	8400	m

**Note:**  
Application class (acc. to ISO 10508) 4; 10 bar.



### Brass tee Press/Click

GROUP: F

Size [mm]	*	Code			UM
16×8×16		1809257000	5	60	pc.



### Brass coupling Press/Click

GROUP: F

Size [mm]	*	Code			UM
16×8		1809042001	20	200	pc.



### Brass nickel-plated eurocone adapter Click

GROUP: F

Size [mm]	*	Code			UM
8×1 / G3/4"		1809271000	15	150	pc.



### Straight brass coupling Click

GROUP: F

Size [mm]	*	Code			UM
8×1		1809042000	20	200	pc.



coil bar pipes in tube bag carton box pallet **N** new available soon

\* custom-made - lead time max 4 weeks | \*\* availability as agreed | \*\*\* while stock lasts

## Floor/wall heating and cooling

### bluePERT pipe - coil

GROUP: C

Size [mm]	*	Code			UM
12×2,0	***	1829198152	80	1600	m
12×2,0		1829198153	200	4000	m
14×2,0		1829198182	600	3000	m
16×2,0		1829198175	200	3000	m
16×2,0		1829198183	600	2400	m
18×2,0		1829198176	200	3000	m
18×2,0		1829198164	600	2400	m
20×2,0		1829198178	200	1800	m
20×2,0		1829198179	300	2100	m
20×2,0		1829198180	600	1800	m
25×2,5	**	1829198181	220	880	m

**Note:**  
Application class 4; 6 bar.



### PEXC pipe - coil

GROUP: C


Size [mm]	*	Code			UM
12×2,0		1129200055	200	4000	m
14×2,0		1129200056	200	4000	m
16×2,0		1829200009	200	3000	m

**Note:**  
Diameter 12×2,0 - 16×2,0 mm application class (acc. to ISO 10508) 4; 10 bar.  
Diameter 20×2,0 mm application class (acc. to ISO 10508) 4; 8 bar.



### PERT pipe - coil

GROUP: C

Size [mm]	*	Code			UM
12×2,0		1129198094	200	4000	m
14×2,0		1129198076	200	4000	m
16×2,0		1029198001	200	3000	m
18×2,0		1129198096	200	3000	m
20×2,0		1029198000	200	1800	m
25×3,5		1129198070	50	1000	m

**Note:**  
Diameter 20×2,0 mm application class (acc. to ISO 10508) 4; 8 bar.  
Other diameters application class (acc. to ISO 10508) 4; 10 bar.



### PERTAL pipe - coil

GROUP: B

Size [mm]	*	Code			UM
16×2,0		1029196031	600	2400	m
16×2,0		1029196123	200	3000	m
20×2,0		1029196092	100	1500	m
25×2,5		1029196081	50	750	m

**Note:**  
Application class (acc. to ISO 10508) 4; 10 bar.



 coil  bar  pipes in tube  bag  carton box  pallet **N** new **i** available soon

\* custom-made - lead time max 4 weeks | \*\* availability as agreed | \*\*\* while stock lasts



## bluePERTAL pipe - coil

GROUP: C

Size [mm]	*	Code			UM
N 16×2,0		1829198200	200	3000	m
N 16×2,0		1829198201	600	2400	m

**Note:**  
Application class 4; 6 bar.



## Brass female eurocone adapter for PERT and PEXC pipes

GROUP: A

Size [mm]	*	Code			UM
12×2,0 G½"		1110271002	15	300	pc.
12×2,0 G¾"		1110271003	10	150	pc.
14×2,0 G½"		1110271000	15	300	pc.
14×2,0 G¾"		1110271005	10	150	pc.
16×2,0 G¾"		1110271010	10	150	pc.
18×2,0 G¾"		1110271006	10	150	pc.
18×2,5 G¾"	***	1110271008	10	150	pc.
20×2 G¾"		1110271011	10	150	pc.
25×3,5 G1"		1110271001	5	80	pc.

**Note:**  
The adapter makes it possible to connect PEXC and PERT pipes with manifolds (equipped with nipples), nipples and fittings for adapter connections.



## Compression ring

GROUP: A

Size [mm]	*	Code			UM
12		1110226001	100	1000	pc.
14		1110226002	10	500	pc.
16		1110226000	10	600	pc.
18		1110226004	10	500	pc.
20		1110226006	100	1000	pc.
25		1110226003	50	500	pc.

**Note:**  
Use for all brass threaded couplings (connectors, adapters) except for plastic threaded couplings.



## Brass female inlet connection for PERTAL pipes

GROUP: A

Size [mm]	*	Code			UM
16 G½"		1010040003	10	160	pc.
16 G¾"		1010040006	10	120	pc.
20 G¾"		1010040011	10	120	pc.
20 G1"	***	1010040008	5	80	pc.
25 G1"		1010040013	10	80	pc.
26 G1"	***	1010040015	5	80	pc.

**Note:**  
The above elements are available as nickel-plated on special request (delivery time - 4 weeks).

## PPSU female universal eurocone adapter

GROUP: A

Size [mm]	*	Code			UM
16 G $\frac{3}{4}$ "		1010271005	10	150	pc.

**Note:**

The adapter works with PEXC, PERT and PERTAL pipes.



## Brass female universal eurocone adapter

GROUP: A

Size [mm]	*	Code			UM
16 G $\frac{1}{2}$ "		1010271001	10	160	pc.
16 G $\frac{3}{4}$ "		1010271002	10	150	pc.
20 G $\frac{3}{4}$ "		1010271008	10	120	pc.

**Note:**

Adapters are compatible with fittings for adapter connections, manifolds through manifold nipples. The adapter works with PEXC, PERT, PERTAL, bluePERT and bluePERTAL pipes.



## Threaded male brass connector for PERTAL pipes

GROUP: A

Size [mm]	*	Code			UM
16 G $\frac{1}{2}$ "		1010045000	10	150	pc.
16 G $\frac{3}{4}$ "		1010045001	10	150	pc.



**Note:**

This fitting is adapted for direct screwing into the manifold beam - sealing of the connection in the manifold is done by means of an O-Ring seal.



## Brass threaded connector for PEXC and PERT pipes

GROUP: A

Size [mm]	*	Code			UM
12x2,0		1110042003	10	120	pc.
14x2,0		1110042005	10	120	pc.
16x2,0		1110042006	10	150	pc.
18x2,0		1110042008	10	120	pc.
20x2,0	*	1110245000	10	120	pc.
25x3,5		1110042012	4	60	pc.

**Note:**

The coupling is used in repairs (pipes damaged by drilling etc.) and to connect long pipe sections.



## Brass coupling

GROUP: A

Size [mm]	*	Code			UM
12x2,0		1109042008	50	700	pc.





### PPSU coupling

GROUP: A

Size [mm]	*	Code			UM
14×2,0		1109042002	10	160	pc.
18×2,0		1109042004	10	160	pc.
25×3,5		1109042007	5	80	pc.



### Brass ring

GROUP: A

Size [mm]	*	Code			UM
12×2,0		1109226003	50	700	pc.
14×2,0		1109226004	50	700	pc.
18×2,0 / 18×2,5		1109226006	50	500	pc.
25×3,5		1109226009	20	200	pc.

**Note:**  
Used for PEXC or PERT pipes with the EVOH layer.  
When assembling Push connectors, use tools with appropriate inserts.  
Place the brass ring with the chamfered edge towards the fitting to be connected.



### PPSU coupling

GROUP: F

Size [mm]	*	Code			UM
16×2,0		1009042013	10	160	pc.
20×2,0		1009042015	10	150	pc.
25×2,5		1009042017	5	60	pc.

**Note:**  
Tools for assembling couplings are available in the System KAN-therm ultraPRESS section.



### Brass coupling

GROUP: F

Size [mm]	*	Code			UM
14×2,0	*	1009042024	10	160	pc.

**Note:**  
Tools for assembling couplings are available in the System KAN-therm ultraPRESS section.



## Tacker - pipe mounting system

### Foamed polystyrene board EPS100 038 (PS20) 5 m<sup>2</sup> sheet with metallized foil

GROUP: A1

Size	*	Code		UM
20 mm (1x5 m)	***	1818211034	1	pc.
30 mm (1x5 m)	***	1818211027	1	pc.



### Foamed polystyrene board EPS100 038 (PS20) 5 m<sup>2</sup> sheet with laminated foil

GROUP: A1

Size	*	Code		UM
30 mm (1x5 m)	***	1818211036	1	pc.
50 mm (1x5 m)		1818211647	5	m <sup>2</sup>



### Foamed polystyrene board EPS200 036 (PS30) 5 m<sup>2</sup> sheet with metallized foil

GROUP: A1

Size	*	Code		UM
30 mm (1x5 m)	***	1818211013	1	pc.



### Foamed polystyrene board EPS100 038 (PS20) 10 m<sup>2</sup> (cube) sheet with metallized foil

GROUP: A1

Size	*	Code		UM
 20 mm (1x10 m)		1818211639	10	m <sup>2</sup>
 30 mm (1x10 m)		1818211638	10	m <sup>2</sup>



### Foamed polystyrene board EPS100 038 (PS20) 10 m<sup>2</sup> (cube) sheet with laminated foil

GROUP: A1

Size	*	Code		UM
 30 mm (1x10 m)		1818211640	10	m <sup>2</sup>



### Laminated foil for KAN-therm Tacker system

GROUP: A

Size	*	Code		UM
130 μm (50 x 1,03 m)		1800183000	50	m



 coil  bar  pipes in tube  bag  carton box  pallet  new  available soon

\* custom-made - lead time max 4 weeks | \*\* availability as agreed | \*\*\* while stock lasts



### Adhesive tape with KAN-therm logo

GROUP: A

Size [m]	*	Code		UM
60		1800183013	1	pc.



### U42 clips for tacker assembly (50 pcs. block)

GROUP: A

Size	*	Code		UM
14-18 (42 mm) 1000 pc.		1800191001	1	pack.
14-18 (42 mm) 300 pc.		1800191010	1	pack.



### U42 clips for tacker assembly (30 pcs. block)

GROUP: A

Size	*	Code		UM
20 (42 mm) 300 pc.		1800191006	1	pack.



### U42 welded clips for tacker assembly (25 pcs. block)

GROUP: A

Size	*	Code			UM
<b>N</b> 14-18 (42 mm) 300 pc..		1800191031	1	30	pack.



### U42 clips for manual assembly

GROUP: A

Size	*	Code			UM
14-18 (42 mm) 100 pc.		1800191000	1	30	pack.
14-18 (42 mm) 200 pc.		1800191002	1	15	pack.



### U55 clips for tacker assembly (25 pcs. block)

GROUP: A

Size	*	Code		UM
14-18 (55 mm) 500 pc.		1800191021	1	pack.

coil 
 bar 
 pipes in tube 
 bag 
 carton box 
 pallet 
 **N** new 
 available soon

\* custom-made - lead time max 4 weeks | \*\* availability as agreed | \*\*\* while stock lasts

**U55 welded clips for tacker assembly (25 pcs. block)**

**GROUP: A**

Size	*	Code			UM
<b>N</b> 14-18 (55 mm) 300 pc.		<b>1800191032</b>	1	12	pack.



 coil 
  bar 
  pipes in tube 
  bag 
  carton box 
  pallet 
 **N** new 
  available soon


\* custom-made - lead time max 4 weeks | \*\* availability as agreed | \*\*\* while stock lasts

## Rail - pipe mounting system



### Mounting rail for pipes

GROUP: A

Pipe size [mm]	*	Code		UM
16		1800209027	2	m
18		1800209028	2	m
20		1800209011	2	m

**Note:**

Mounting rails make it possible to lay pipes with 5 cm spacing.

Rail dimensions [height x length]:

1800209027 - 25 mm x 2 m,

1800209028 - 25 mm x 2 m,

1800209011 - 25 mm x 2 m.



### Mounting rail for pipes

GROUP: A

Pipe size [mm]	*	Code		UM
12-17		1800209000	1	m
16-17		1800209001	1	m
12-22		1800209009	1	m
<b>N</b> 25		1800209026	1	m

**Note:**

Rails 1800209000 and 1800209009 make it possible to lay pipes with 10 cm spacing.

Rails 1800209001 and 1800209026 make it possible to lay pipes with 5 cm spacing.

Rails dimensions [height x length (number of connected sections x length of section)]:

1800209000 - 23 mm x 1 m (5 x 0,2 m).

1800209001 - 24 mm x 1 m (2 x 0,5 m)

1800209009 - 29 mm x 1 m (2 x 0,5 m)

1800209026 - 32 mm x 1 m (2 x 0,5 m)

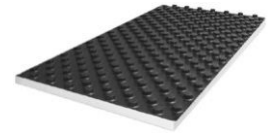
## Profil - pipe mounting system

### Profil1 foamed polystyrene EPS T-24 dB (sound-absorbing) board with PS foil - 1,12 m<sup>2</sup> sheet

GROUP: A1

Pipe size [mm] / Board dimensions	*	Code		UM
16-18 / 30-2 mm (0,8 × 1,4 m)	*	1818211651	6,72	m <sup>2</sup>

Total thickness of the board with the profiled part is 51 mm.  
Dimension includes change in thickness caused by load.

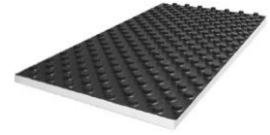


### Profil2 foamed polystyrene EPS200 036 (PS30) board 1,12 m<sup>2</sup> sheet

GROUP: A1

Pipe size [mm] / Board dimensions	*	Code		UM
16-18 / 30-2 mm (0,8 × 1,4 m)	*	1818211650	14,56	m <sup>2</sup>

Total thickness of the board with the profiled part is 32 mm.

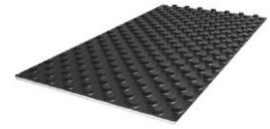


### Profil3 profiled PS foil 1.12 m<sup>2</sup> sheet

GROUP: A1

Pipe size [mm] / Board dimensions	*	Code		UM
16-18 / 1 mm (0,8 × 1,4 m)	*	1818211652	13,44	m <sup>2</sup>

Total height of the foil with the profiled part is 20 mm.



### Profil4 foamed polystyrene EPS200 board 0.72 m<sup>2</sup> sheet

GROUP: A1

Pipe size [mm] / Board dimensions	*	Code		UM
16-18 / 22 mm (1,2 × 0,6 m)	*	1818211646	8,64	m <sup>2</sup>

Total thickness of the board with the profiled part is 43 mm.



 coil
  bar
  pipes in tube
  bag
  carton box
  pallet
  new
  available soon

\* custom-made - lead time max 4 weeks | \*\* availability as agreed | \*\*\* while stock lasts

## TBS - pipe mounting system



### TBS foamed polystyrene EPS150 036 (PS30) board 0.5 m<sup>2</sup> sheet **GROUP: A1**

Pipe size [mm] / Board dimensions	*	Code		UM
16 / 25 mm (0,5 × 1,0 m)		<b>1818211645</b>	10	m <sup>2</sup>



### TBS metal profile **GROUP: A**

Size	*	Code			UM
0,4 mm (1,0 × 0,12 m)		<b>1800213000</b>	1	50	pc.

**Note:**

The profile is made of galvanised steel. The profile works only with 16 mm pipes.



### TBS foamed polystyrene EPS200 036 (PS30) board 0.5 m<sup>2</sup> sheet **GROUP: A1**

Size	*	Code		UM
25 mm (0,5 × 1,0 m)	*	<b>1818211649</b>	12	m <sup>2</sup>

 coil 
  bar 
  pipes in tube 
  bag 
  carton box 
  pallet 
  new 
  available soon

\* custom-made - lead time max 4 weeks | \*\* availability as agreed | \*\*\* while stock lasts

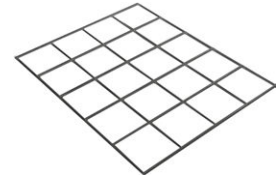
# NET - pipe mounting system

## Steel wire NET

**GROUP: A**

Size	*	Code		UM
1,2 m × 2,1 m - 2,52 m <sup>2</sup>	*	<b>1800183054</b>	2,52	m <sup>2</sup>

**Note:**  
The net is made of 3 mm thick steel wire. Mesh size - 150×150 mm.



## Grip for fastening pipes on NET

**GROUP: A**

Size [mm]	*	Code			UM
3 / 16-18		<b>1800107001</b>	100	1000	pc.
3 / 20	*	<b>1800107002</b>	100	1000	pc.



## Plastic band for fastening pipes on NET

**GROUP: A**

	*	Code			UM
	*	<b>1800107018</b>	100	1000	pc.



## Fastening band for connecting NETs

**GROUP: A**

	*	Code		UM
	*	<b>1800183008</b>	1000	pc.



## Peg for foil fastening - L = 94 mm

**GROUP: A**

Size [mm]	*	Code			UM
8		<b>1800183003</b>	100	1000	pc.




## Floor heating accessories



### Corrugated protecting pipe red

GROUP: A

Size [mm]	*	Code		UM
12-14 (23 mm)		1700049067	100	m
16-18 (25 mm)		1700049063	50	m
20 (28 mm)		1700049069	50	m
25-26 (35 mm)		1700049065	50	m
32 (43 mm)		1700049071	50	m
40 (50 mm)		1700049073	25	m


**Note:**

Use in cold and hot potable water installations and central heating as a protecting pipe when pouring concrete over the installation. The values given in parentheses are for the outside diameter of the corrugated protecting pipe.



### Corrugated protecting pipe blue

GROUP: A

Size [mm]	*	Code		UM
12-14 (23 mm)		1700049068	100	m
16-18 (25 mm)		1700049064	50	m
20 (28 mm)		1700049070	50	m
25-26 (35 mm)		1700049066	50	m
32 (43 mm)		1700049072	50	m
40 (50 mm)		1700049074	25	m

**Note:**

Use in cold and hot potable water installations and central heating as a protecting pipe when pouring concrete over the installation. The values given in parentheses are for the outside diameter of the corrugated protecting pipe.



### Concrete additive BETOKAN

GROUP: A

Capacity	*	Code		UM
5 l		1800014003	1	pack.
10 l		1800014001	1	pack.

**Note:**

Use for underfloor heating to improve the strength of concrete.



### Concrete additive BETOKAN Plus

GROUP: A

Capacity	*	Code		UM
10 l		1800014005	1	pack.

**Note:**

Use for underfloor heating to improve the strength of concrete. It makes it possible to reduce the thickness of the screed to 4.5 cm above insulation.

 coil  bar  pipes in tube  bag  carton box  pallet **N** new  available soon

\* custom-made - lead time max 4 weeks | \*\* availability as agreed | \*\*\* while stock lasts



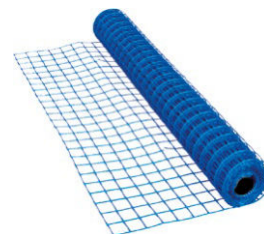
## Fiberglass mesh for floor reinforcement

GROUP: A

Size	*	Code		UM
1×50 m		1800183044	50	m <sup>2</sup>

**Note:**

The mesh used with BETOKAN or BETOKAN Plus increases the flexibility of the screed and provides an excellent protection against creating any possible cracks or offsets (keep the floor surface even). Meshes size 13×13 mm.



## Antifreeze agent for installation

GROUP: A

Version	*	Code		UM
-20 °C - 20 l	*	1800002002	1	pack.
-25 °C - 20 l	*	1800002003	1	pack.
-35 °C - 20 l	*	1800002004	1	pack.

**Note:**

Use for central heating, air-conditioning, cooling and solar installations.



## Edge tape with perforation

GROUP: A

Size [mm]	*	Code			UM
8×150		1818255002	25	150	m

**Note:**

Use to insulate underfloor heating plates from walls.



## Edge tape with perforation and foil

GROUP: A

Size [mm]	*	Code			UM
8×150		1818255003	25	150	m

**Note:**

Use to insulate underfloor heating plates from walls.



## Expansion joint profile with feet

GROUP: A

Size [mm]	*	Code			UM
10×150		1800255000	25	150	m

**Note:**

Use to make expansion joints for underfloor heating plates. The pipes going through the expansion joint should be laid in a corrugated pipe.



## Expansion joint - PE foam

GROUP: A

	*	Code			UM
		1800183007	2	200	m



 coil  bar  pipes in tube  bag  carton box  pallet  new  available soon

\* custom-made - lead time max 4 weeks | \*\* availability as agreed | \*\*\* while stock lasts



### Expansion joint - rail

GROUP: A

	*	Code			UM
		1800209029	2	50	m



### Expansion joint - corrugated pipe

GROUP: A

Size [m]	*	Code			UM
0,4		1700183010	1	60	pc.



### PE foil

GROUP: A

Size	*	Code		UM
0,2 mm (2,0 x 50 m)		1818183000	100	m <sup>2</sup>


**Note:**

Use as an installation cover before laying dry screed panels.  
 Use as damp-proof insulation of a underfloor heating and cooling plate.  
 Use as damp-proof insulation under the NET mesh.

## Manifolds and manifold accessories

### InoxFlow manifold with control valves (UVN series)

GROUP: E

Number of circuits (H×W×D) [mm]	*	Code		UM
2 (325×140×84)		1316160022	1	pc.
3 (325×190×84)		1316160023	1	pc.
4 (325×240×84)		1316160024	1	pc.
5 (325×290×84)		1316160025	1	pc.
6 (325×340×84)		1316160026	1	pc.
7 (325×390×84)		1316160027	1	pc.
8 (325×440×84)		1316160028	1	pc.
9 (325×490×84)		1316160029	1	pc.
10 (325×540×84)		1316160030	1	pc.
11 (325×590×84)		1316160031	1	pc.
12 (325×640×84)		1316160032	1	pc.



**Note:**

The manifold works with G $\frac{3}{4}$ " eurocone adapters and G $\frac{3}{4}$ " connectors.  
 Outlets for individual circuits have 50 mm spacing.  
 Manifold supply - upper beam.  
 Return from manifold - lower beam.  
 Beams have G1" female thread.

### MARKING OF MANIFOLD SERIES



|
|
|
  
**R or U    B,N,S,V or F    T, A or P**

**Radiator**  
manifolds for central heating and drinking water

**Underfloor heating**  
manifolds for underfloor heating

**equipment of top or bottom beams**

**Basic**  
no accessories

**Nipples**

**Servomotor valves**

**Valves**  
shut-off or balancing valves

**Flowmeters**

**additional accessories**

**Top**  
air-vent on top of the beam


**Axis**  
air-vent in the axis of the beam

**Pump**  
mixing unit



## InoxFlow manifold with flowmeters (UFN series)

GROUP: E

Number of circuits (H×W×D) [mm]	*	Code		UM
2 (352×140×84)		<b>1316157055</b>	1	pc.
3 (352×190×84)		<b>1316157056</b>	1	pc.
4 (352×240×84)		<b>1316157057</b>	1	pc.
5 (352×290×84)		<b>1316157058</b>	1	pc.
6 (352×340×84)		<b>1316157059</b>	1	pc.
7 (352×390×84)		<b>1316157060</b>	1	pc.
8 (352×440×84)		<b>1316157061</b>	1	pc.
9 (352×490×84)		<b>1316157062</b>	1	pc.
10 (352×540×84)		<b>1316157063</b>	1	pc.
11 (352×590×84)		<b>1316157064</b>	1	pc.
12 (352×640×84)		<b>1316157065</b>	1	pc.

### Note:

The manifold works with G $\frac{3}{4}$ " eurocone adapters and G $\frac{3}{4}$ " connectors.  
 Outlets for individual circuits have 50 mm spacing.  
 Flowmeter adjustment range 0 - 2.5 l/min.  
 Manifold supply - upper beam.  
 Return from manifold - lower beam.  
 Beams have G1" female thread.

## MARKING OF MANIFOLD SERIES



R or U      B,N,S,V or F      T, A or P

**Radiator**  
manifolds for central heating and drinking water

**Underfloor heating**  
manifolds for underfloor heating

**equipment of top or bottom beams**

**Basic**  
no accessories

**Nipples**

**Servomotor valves**

**Valves**  
shut-off or balancing valves

**Flowmeters**

**additional accessories**


**Top**  
air-vent on top of the beam

**Axis**  
air-vent in the axis of the beam

**Pump**  
mixing unit

## InoxFlow manifold with servomotor valves and control valves (UVS series)

GROUP: E

Number of circuits (H×W×D) [mm]	*	Code		UM
2 (325×140×84)		1316160033	1	pc.
3 (325×190×84)		1316160034	1	pc.
4 (325×240×84)		1316160035	1	pc.
5 (325×290×84)		1316160036	1	pc.
6 (325×340×84)		1316160037	1	pc.
7 (325×390×84)		1316160038	1	pc.
8 (325×440×84)		1316160039	1	pc.
9 (325×490×84)		1316160040	1	pc.
10 (325×540×84)		1316160041	1	pc.
11 (325×590×84)		1316160042	1	pc.
12 (325×640×84)		1316160043	1	pc.



**Note:**

The manifold works with G $\frac{3}{4}$ " eurocone adapters and G $\frac{3}{4}$ " connectors.  
 Outlets for individual circuits have 50 mm spacing.  
 Use servomotors with M30×1.5 adapter.  
 Manifold supply - upper beam.  
 Return from manifold - lower beam.  
 Beams have G1" female thread.

### MARKING OF MANIFOLD SERIES



R or U      B,N,S,V or F      T, A or P

**Radiator**  
manifolds for central heating and drinking water

**Underfloor heating**  
manifolds for underfloor heating

**equipment of top or bottom beams**

**Basic**  
no accessories

**Nipples**

**Servomotor valves**

**Valves**  
shut-off or balancing valves

**Flowmeters**

**additional accessories**

**Top**  
air-vent on top of the beam


**Axis**  
air-vent in the axis of the beam

**Pump**  
mixing unit



## InoxFlow manifold with servomotor valves and control valves (UVST series)

**GROUP: E**

Number of circuits (H×W×D) [mm]	*	Code		UM
2 (336×190×84)		<b>1316157128</b>	1	pc.
3 (336×240×84)		<b>1316157129</b>	1	pc.
4 (336×290×84)		<b>1316157130</b>	1	pc.
5 (336×340×84)		<b>1316157131</b>	1	pc.
6 (336×390×84)		<b>1316157132</b>	1	pc.
7 (336×440×84)		<b>1316157133</b>	1	pc.
8 (336×490×84)		<b>1316157134</b>	1	pc.
9 (336×540×84)		<b>1316157135</b>	1	pc.
10 (336×590×84)		<b>1316157136</b>	1	pc.
11 (336×640×84)		<b>1316157137</b>	1	pc.
12 (336×690×84)		<b>1316157138</b>	1	pc.

**Note:**

The manifold works with G $\frac{3}{4}$ " eurocone adapters and G $\frac{3}{4}$ " connectors.  
 Outlets for individual circuits have 50 mm spacing.  
 Use servomotors with M30×1.5 adapter.  
 Manifold supply - upper beam.  
 Return from manifold - lower beam.  
 Beams have G1" female thread.  
 The supply and return beam have G1" stop end mounted on one side.

### MARKING OF MANIFOLD SERIES



| | | |  
**R or U    B,N,S,V or F    T, A or P**

**Radiator**  
manifolds for central heating and drinking water

**Underfloor heating**  
manifolds for underfloor heating

**equipment of top or bottom beams**

**Basic**  
no accessories

**Nipples**

**Servomotor valves**

**Valves**  
shut-off or balancing valves

**Flowmeters**

**additional accessories**


**Top**  
air-vent on top of the beam

**Axis**  
air-vent in the axis of the beam

**Pump**  
mixing unit

## InoxFlow manifold with servomotor valves and flowmeters (UFS series)

GROUP: E

Number of circuits (H×W×D) [mm]	*	Code		UM
2 (352×140×84)		1316157066	1	pc.
3 (352×190×84)		1316157067	1	pc.
4 (352×240×84)		1316157068	1	pc.
5 (352×290×84)		1316157069	1	pc.
6 (352×340×84)		1316157070	1	pc.
7 (352×390×84)		1316157071	1	pc.
8 (352×440×84)		1316157072	1	pc.
9 (352×490×84)		1316157073	1	pc.
10 (352×540×84)		1316157074	1	pc.
11 (352×590×84)		1316157075	1	pc.
12 (352×640×84)		1316157076	1	pc.



**Note:**

The manifold works with G $\frac{3}{4}$ " eurocone adapters and G $\frac{3}{4}$ " connectors.  
 Outlets for individual circuits have 50 mm spacing.  
 Flowmeter adjustment range 0 - 2.5 l/min.  
 Use servomotors with M30×1.5 adapter.  
 Manifold supply - upper beam.  
 Return from manifold - lower beam.  
 Beams have G1" female thread.

### MARKING OF MANIFOLD SERIES



R or U    B,N,S,V or F    T, A or P

**Radiator**  
manifolds for central heating and drinking water

**Underfloor heating**  
manifolds for underfloor heating

**equipment of top or bottom beams**

**Basic**  
no accessories

**Nipples**

**Servomotor valves**

**Valves**  
shut-off or balancing valves

**Flowmeters**

**additional accessories**

**Top**  
air-vent on top of the beam


**Axis**  
air-vent in the axis of the beam

**Pump**  
mixing unit



## InoxFlow manifold with servomotor valves and flowmeters (UFST series)

GROUP: E

Number of circuits (H×W×D) [mm]	*	Code		UM
2 (362×190×84)		1316157077	1	pc.
3 (362×240×84)		1316157078	1	pc.
4 (362×290×84)		1316157079	1	pc.
5 (362×340×84)		1316157080	1	pc.
6 (362×390×84)		1316157081	1	pc.
7 (362×440×84)		1316157082	1	pc.
8 (362×490×84)		1316157083	1	pc.
9 (362×540×84)		1316157084	1	pc.
10 (362×590×84)		1316157085	1	pc.
11 (362×640×84)		1316157086	1	pc.
12 (362×690×84)		1316157087	1	pc.

### Note:

The manifold works with G $\frac{3}{4}$ " eurocone adapters and G $\frac{3}{4}$ " connectors.  
 Outlets for individual circuits have 50 mm spacing.  
 Flowmeter adjustment range 0 - 2.5 l/min.  
 Use servomotors with M30×1.5 adapter.  
 Manifold supply - upper beam.  
 Return from manifold - lower beam.  
 Beams have G1" female thread.  
 The supply and return beam have G1" stop end mounted on one side.

## MARKING OF MANIFOLD SERIES



R or U      B,N,S,V or F      T, A or P

**Radiator**  
manifolds for central heating and drinking water

**Underfloor heating**  
manifolds for underfloor heating

### equipment of top or bottom beams

**Basic**  
no accessories

**Nipples**

**Servomotor valves**

**Valves**  
shut-off or balancing valves

**Flowmeters**

### additional accessories

**Top**  
air-vent on top of the beam


**Axis**  
air-vent in the axis of the beam

**Pump**  
mixing unit



## InoxFlow manifold with servomotor valves and flowmeters (UFST MAX series)

GROUP: E

Number of circuits (H×W×D) [mm]	*	Code		UM
2 (362×190×84)		1316157139	1	pc.
3 (362×240×84)		1316157140	1	pc.
4 (362×290×84)		1316157141	1	pc.
5 (362×340×84)		1316157142	1	pc.
6 (362×390×84)		1316157143	1	pc.
7 (362×440×84)		1316157144	1	pc.
8 (362×490×84)		1316157145	1	pc.
9 (362×540×84)		1316157146	1	pc.
10 (362×590×84)		1316157147	1	pc.
11 (362×640×84)		1316157148	1	pc.
12 (362×690×84)		1316157149	1	pc.



**Note:**

The manifold works with G $\frac{3}{4}$ " eurocone adapters and G $\frac{3}{4}$ " connectors.  
 Outlets for individual circuits have 50 mm spacing.  
 Flowmeter adjustment range 0 - 5.0 l/min.  
 Use servomotors with M30×1.5 adapter.  
 Manifold supply - upper beam.  
 Return from manifold - lower beam.  
 Beams have G1" female thread.  
 The supply and return beam have G1" stop end mounted on one side.

### MARKING OF MANIFOLD SERIES



R or U    B,N,S,V or F    T, A or P

**Radiator**  
manifolds for central heating and drinking water

**Underfloor heating**  
manifolds for underfloor heating

**equipment of top or bottom beams**

**Basic**  
no accessories

**Nipples**

**Servomotor valves**

**Valves**  
shut-off or balancing valves

**Flowmeters**

**additional accessories**

**Top**  
air-vent on top of the beam

**Axis**  
air-vent in the axis of the beam

**Pump**  
mixing unit

## Brass male/female reducer for manifold

GROUP: E

Size	*	Code			UM
G1" / G $\frac{1}{2}$ "		1300220002	10	120	pc.
G1" / G $\frac{3}{4}$ "		1300220003	10	120	pc.

**Note:**

The reducer has an O-Ring seal built-in.  
 When assembling in KAN-therm manifolds, additional sealing is not required.



## Nickel-plated male/female reducer for manifold

GROUP: E

Size	*	Code			UM
G1" / G $\frac{1}{2}$ "		1300220008	10	120	pc.
G1" / G $\frac{3}{4}$ "		1300220009	10	120	pc.

**Note:**

The reducer has an O-Ring seal built-in.  
 When assembling in KAN-therm manifolds, additional sealing is not required.  
 Do not use for potable water.



 coil    bar    pipes in tube    bag    carton box    pallet   **N** new   **i** available soon

\* custom-made - lead time max 4 weeks | \*\* availability as agreed | \*\*\* while stock lasts



### Brass male stop end

GROUP: E

Size	*	Code			UM
G1"		1300025002	10	150	pc.

**Note:**  
The stop end has an O-Ring seal built-in.  
When assembling in KAN-therm manifolds, additional sealing is not required.



### Nickel-plated male stop end

GROUP: E

Size	*	Code			UM
G¾"		1300250021	20	300	pc.
G1"		1300025005	10	120	pc.

**Note:**  
The stop end has an O-Ring seal built-in.  
When assembling in KAN-therm manifolds, additional sealing is not required.  
Do not use for potable water.



### Straight valve set SET-P

GROUP: E

Size	*	Code			UM
G1"		1300183006	1	20	set

**Note:**  
1" valve set with a union, working with KAN-therm manifolds without additional sealing.  
Use when the manifold is supplied from the side.



### Angle valve set SET-K

GROUP: E

Size	*	Code			UM
G1"		1300183007	1	20	set

**Note:**  
1" valve set with a union and elbows, working with KAN-therm manifolds without additional sealing.  
Use when the manifold is supplied from the floor.



### Brass manifold knob

GROUP: E

Size [mm]	*	Code			UM
M28×1,5		1300183001	20	200	pc.
M30×1,5		1300183002	20	200	pc.

**Note:**  
Use the knob on thermostatic valves to shut off the flow through the heating loops:  
M28×1.5 - in the manifolds series 71, 75, 73A, 77A  
M30×1.5 - in the manifolds series 73A, 77A, on a thermostatic valve at the inlet to the mixing unit and on servomotor valves of InoxFlow manifolds.

## Nickel-plated manifold knob

GROUP: E

Size [mm]	*	Code			UM
M30×1,5		1300183051	20	200	pc.

**Note:**

Use the knob on thermostatic valves to shut off the flow through the heating loops:  
 M28×1.5 - in the manifolds series 71, 75, 73A, 77A  
 M30×1.5 - in the manifolds series 73A, 77A, on a thermostatic valve at the inlet to the mixing unit and on servomotor valves of InoxFlow manifolds.



## Brass extension element with flowmeter - L = 50 mm

GROUP: E

Size	*	Code			UM
G1"		1300079049	1	20	pc.

**Note:**

Use the element with 1" nipple to extend the manifold by one circuit.  
 Supply flowmeter adjustment range 0 - 2.5 l/min.



## Brass extension element with control valve - L = 50 mm

GROUP: E

Size	*	Code			UM
G1"		1300079002	1	20	pc.

**Note:**

Use the element with 1" nipple to extend the manifold by one circuit.



## Brass extension element with servomotor valve - L = 50 mm

GROUP: E

Size	*	Code			UM
G1"		1300079048	1	20	pc.

**Note:**

Use the element with 1" nipple to extend the manifold by one circuit.  
 Use adapters for M30×1.5 servomotors.



## Male nipple with gasket

GROUP: E

Size	*	Code			UM
G1"		1300174028	10	100	pc.

**Note:**

Use to connect manifolds with extension elements.





### Male nickel-plated nipple with gasket

GROUP: E

Size	*	Code			UM
G1"		1300174042	10	100	pc.

**Note:**  
Do not use for potable water. Use to connect manifolds with extension elements.



### Tee with gasket

GROUP: E

Size	*	Code			UM
G1" / G½" / G½"		1300257001	5	70	pc.

**Note:**  
Use the element in manifolds to extend a manifold by one circuit or add an air vent and drain valve.



### Nickel-plated tee with gasket

GROUP: E

Size	*	Code			UM
G1" / G½" / G½"		1300257003	5	70	pc.

**Note:**  
Use the element in manifolds to extend a manifold by one circuit or add an air vent and drain valve.  
Do not use for potable water.



### Brass male stop end

GROUP: E

Size	*	Code			UM
G½"		1709250004	20	300	pc.

**Note:**  
The stop end has its O-Ring seal. Use a hex12 Allen wrench for tightening.



### Nickel-plated male stop end

GROUP: E

Size	*	Code			UM
G½"		1300250020	20	300	pc.

**Note:**  
The stop end has an O-Ring. Use a hex12 Allen wrench for tightening. Do not use for potable water.

### Tee with air vent and drain valve

GROUP: E

Size	*	Code			UM
G1"		1300257002	1	20	pc.



### Nickel-plated tee with air vent and drain valve

GROUP: E

Size	*	Code			UM
G1"		1300257004	10	80	pc.

**Note:**  
Do not use for potable water.



### Manual air vent

GROUP: E

Size	*	Code			UM
G½"		1300005004	50	500	pc.



### Plastic air vent and drain valve

GROUP: E

Size	*	Code			UM
G½"		1300005003	25	100	pc.



### Metal air vent and drain valve

GROUP: E

Size	*	Code			UM
G½"		1300277000	25	100	pc.



 coil  bar  pipes in tube  bag  carton box  pallet **N** new **i** available soon

\* custom-made - lead time max 4 weeks | \*\* availability as agreed | \*\*\* while stock lasts



### Air vent with stop valve

GROUP: E

Size	*	Code			UM
G1/2"		1300005000	1	25	pc.

**Note:**  
The stop valve makes it possible to remove the air vent without the necessity to drain the installation.  
Use tow for sealing.



### Nickel-plated air vent with stop valve

GROUP: E

Size	*	Code			UM
1/2"		1300005006	1	100	pc.

**Note:**  
The stop valve makes it possible to remove the air vent without the necessity to drain the installation.  
Use tow for sealing.



### Dial thermometer - red

GROUP: E

Version	*	Code		UM
100 °C	*	1300264001	1	pc.




### Dial thermometer - blue

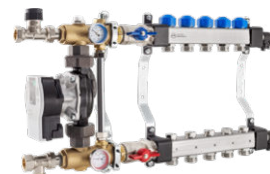
GROUP: E

Version	*	Code		UM
100 °C	*	1300264002	1	pc.

## InoxFlow manifold with mixing unit (USVP series)

GROUP: E

Size (H×W×D) [mm]	*	Code		UM
2 (410×451×123)		1316160044	1	pc.
3 (410×501×123)		1316160045	1	pc.
4 (410×551×123)		1316160046	1	pc.
5 (410×601×123)		1316160047	1	pc.
6 (410×651×123)		1316160048	1	pc.
7 (410×701×123)		1316160049	1	pc.
8 (410×751×123)		1316160050	1	pc.
9 (410×801×123)		1316160051	1	pc.
10 (410×851×123)		1316160052	1	pc.



**Note:**

Use adapters for M30×1.5 servomotors on the upper beam.

Use the manifold with an integrated mixing unit in the installations of the maximum heat load up to 15 kW\*.

\*Assuming the following parameters: loop diameter 16×2 mm, loop length up to 100 m, pipe spacing 15 cm, supply/return temperature 40/30°C.

Do not use with low-parameter heat sources.

### MARKING OF MANIFOLD SERIES



R or U    B,N,S,V or F    T, A or P

**Radiator**  
manifolds for central heating and drinking water

**Underfloor heating**  
manifolds for underfloor heating

equipment of top or bottom beams

**Basic**  
no accessories

**Nipples**

**Servomotor valves**

**Valves**  
shut-off or balancing valves

**Flowmeters**

additional accessories


**Top**  
air-vent on top of the beam

**Axis**  
air-vent in the axis of the beam

**Pump**  
mixing unit

## InoxFlow manifold with mixing unit (USFP series)

GROUP: E

Size (H×W×D) [mm]	*	Code		UM
2 (410×451×123)		1316157088	1	pc.
3 (410×501×123)		1316157089	1	pc.
4 (410×551×123)		1316157090	1	pc.
5 (410×601×123)		1316157091	1	pc.
6 (410×651×123)		1316157092	1	pc.
7 (410×701×123)		1316157093	1	pc.
8 (410×751×123)		1316157094	1	pc.
9 (410×801×123)		1316157095	1	pc.
10 (410×851×123)		1316157096	1	pc.



**Note:**

Use adapters for M30×1.5 servomotors on the upper beam.

### MARKING OF MANIFOLD SERIES



R or U    B,N,S,V or F    T, A or P

**Radiator**  
manifolds for central heating and drinking water

**Underfloor heating**  
manifolds for underfloor heating

equipment of top or bottom beams

**Basic**  
no accessories

**Nipples**

**Servomotor valves**

**Valves**  
shut-off or balancing valves

**Flowmeters**

additional accessories

**Top**  
air-vent on top of the beam

**Axis**  
air-vent in the axis of the beam

**Pump**  
mixing unit

 coil  bar  pipes in tube  bag  carton box  pallet **N** new  available soon

\* custom-made - lead time max 4 weeks | \*\* availability as agreed | \*\*\* while stock lasts



## Electronic pump group

GROUP: E

	*	Code		UM
		1346103000	1	pc.

**Note:**

Use the manifold with an integrated mixing unit in the installations of the maximum heat load up to 15 kW\*.

\*Assuming the following parameters:

- loop diameter 16×2 mm,
- loop length up to 100 m,
- pipe spacing 15 cm,
- supply/return temperature 40/30°C.

Do not use with low-parameter heat sources.



## Pump group with three-way thermostatic mixing valve - Kvs = 1.6

GROUP: E

Version	*	Code		UM
35-60 °C		1300103001	1	pc.
20-43 °C		1300103003	1	pc.

**Note:**

Use the manifold with an integrated mixing unit in the installations of the maximum heat load up to 7.5 kW\*.

\*Assuming the following parameters:

- loop diameter 16×2 mm,
- loop length up to 100 m,
- pipe spacing 15 cm,
- supply/return temperature 40/30°C.



## Pump group with three-way thermostatic mixing valve - Kvs = 2.5

GROUP: E

Version	*	Code		UM
20-43 °C		1346103005	1	pc.

**Note:**

Use the manifold with an integrated mixing unit in the installations of the maximum heat load up to 15 kW\*.

\*Assuming the following parameters:

- loop diameter 16×2 mm,
- loop length up to 100 m,
- pipe spacing 15 cm,
- supply/return temperature 40/30°C.



## Brass manifold with servomotor valves and flowmeters (75A series)


GROUP: E

Number of circuits (H×W×D) [mm]	*	Code		UM
2 (100×330×80)		1346157011	1	pc.
3 (150×330×80)		1346157012	1	pc.
4 (200×330×80)		1346157013	1	pc.
5 (250×330×80)		1346157014	1	pc.
6 (300×330×80)		1346157015	1	pc.
7 (350×330×80)		1346157016	1	pc.
8 (400×330×80)		1346157017	1	pc.
9 (450×330×80)		1346157018	1	pc.
10 (500×330×80)		1346157019	1	pc.
11 (550×330×80)		1346157020	1	pc.
12 (600×330×80)		1346157021	1	pc.



### Plastic manifold 1 1/2" x 3/4"

GROUP: E

	Number of circuits	*	Code		UM
<b>N</b>	2	*	1328155000	1	pc.
<b>N</b>	3	*	1328155001	1	pc.
<b>N</b>	4	*	1328155002	1	pc.
<b>N</b>	5	*	1328155003	1	pc.
<b>N</b>	6	*	1328155004	1	pc.
<b>N</b>	7	*	1328155005	1	pc.
<b>N</b>	8	*	1328155006	1	pc.
<b>N</b>	9	*	1328155007	1	pc.
<b>N</b>	10	*	1328155008	1	pc.
<b>N</b>	11	*	1328155009	1	pc.
<b>N</b>	12	*	1328155010	1	pc.
<b>N</b>	13	*	1328155011	1	pc.
<b>N</b>	14	*	1328155012	1	pc.
<b>N</b>	15	*	1328155013	1	pc.
<b>N</b>	16	*	1328155014	1	pc.

**Note:**

The manifold is equipped with a 4-20 l/min flowmeter.



### Plastic manifold 1 1/2" x 1"

GROUP: E

	Number of circuits	*	Code		UM
<b>N</b>	2	*	1328155015	1	pc.
<b>N</b>	3	*	1328155016	1	pc.
<b>N</b>	4	*	1328155017	1	pc.
<b>N</b>	5	*	1328155018	1	pc.
<b>N</b>	6	*	1328155019	1	pc.
<b>N</b>	7	*	1328155020	1	pc.
<b>N</b>	8	*	1328155021	1	pc.
<b>N</b>	9	*	1328155022	1	pc.
<b>N</b>	10	*	1328155023	1	pc.
<b>N</b>	11	*	1328155024	1	pc.
<b>N</b>	12	*	1328155025	1	pc.
<b>N</b>	13	*	1328155026	1	pc.
<b>N</b>	14	*	1328155027	1	pc.
<b>N</b>	15	*	1328155028	1	pc.
<b>N</b>	16	*	1328155029	1	pc.

**Note:**

The manifold is equipped with a 4-20 l/min flowmeter.



### Straight thermostatic valve - M30x1,5

GROUP: A

Size	*	Code		UM
Rp1/2"		1700277001	1	pc.

**Note:**

Used as a service element for manifolds series 73E and 77E, as well as KAN-therm pump groups. By using M30x1.5 adapter, electric servomotor and room thermostat, it can be used to adjust temperature for a whole area.





### Straight return valve with pre-set

**GROUP: A**

Size	*	Code		UM
Rp1/2"		1702277000	1	pc.

**Note:**  
Used as a service element for manifolds series 73E and 77E, as well as KAN-therm pump groups.  
It enables hydraulic regulation of surface heating installations - setting supply temperature of heating loops.



### Thermostatic head with pad

**GROUP: A**

Size [mm]	*	Code		UM
M30x1,5		1802108006	1	pc.

**Note:**  
The element is intended for manifolds series 73E and 77E, as well as KAN-therm pump groups - it works as a protection against exceeding a temperature in a surface heating installation.



### Thermostatic head with pad for InoxFlow manifolds

**GROUP: A**



Size [mm]	*	Code		UM
M30x1,5		1802108008	1	pc.

**Note:**  
The element is intended for manifolds series USVP and USFP, as well as KAN-therm pump groups - it works as a protection against exceeding a temperature in a surface heating installation.

## Floor heating cabinets

### Recess mounted cabinet Slim+

GROUP: D

	Size (H×W×D) [mm]	*	Code			UM
N	750-850×450×110-160		1414183018	1	33	pc.
N	750-850×550×110-160		1414183019	1	27	pc.
N	750-850×700×110-160		1414183020	1	21	pc.
N	750-850×850×110-160		1414183021	1	15	pc.
N	750-850×1000×110-160		1414183022	1	14	pc.
N	750-850×1200×110-160		1414183023	1	12	pc.



**STD** - a manifold without additional fixtures, with 1" stop end on one side.

**KPL** - a manifold with SET-K connection valves and a tee with an air vent and a drain valve in a beam.

**+GP H** - a manifold with an integrated set-point mixing unit.

**KPL +GP 3D** - a manifold with a vent and drain valve in a beam, as well as connected mixing pump group with a three-way thermostatic valve.

**OPT** - a manifold with a built-in vent and drain group, as well as SET-K connection valves.

**OPT +GP 3D** - a manifold with a built-in vent and drain group, as well as connected mixing pump group with a three-way thermostatic valve.

The drain and vent group should be taken as additional outlet.

Code	Type	Brass manifold (Max. number of circuits)				InoxFlow manifold (Max. number of circuits)					
		STD	KPL	+GP H	KPL +GP H	STD	KPL	OPT	+GP H	KPL +GP 3D	OPT +GP 3D
1414183018	Slim+ 450	8	3	-	2	7	2	5	-	2	-
1414183019	Slim+ 550	10	5	2	4	9	4	7	-	4	3
1414183020	Slim+ 700	12	8	5	7	12	7	10	4	7	7
1414183021	Slim+ 850	12	11	8	10	13	10	12	7	10	10
1414183022	Slim+ 1000	12	12	11	12	13	12	12	10	12	12
1414183023	Slim+ 1200	12	12	12	12	13	12	12	13	12	12

### Surface mounted cabinet SWN-OP

GROUP: D

	Size (H×W×D) [mm]	*	Code			UM
	710×580×140		1446180000	1	20	pc.
	710×780×140		1446180001	1	14	pc.
	710×930×140		1446180002	1	11	pc.



**Note:**

In the "Size" field, there is given:

- the external dimension of the cabinet body.

**STD** - a manifold without additional fixtures, with 1" stop end on one side.

**KPL** - a manifold with SET-K connection valves and a tee with an air vent and a drain valve in a beam.

**+GP H** - a manifold with an integrated set-point mixing unit.

**KPL +GP 3D** - a manifold with a vent and drain valve in a beam, as well as connected mixing pump group with a three-way thermostatic valve.

**OPT** - a manifold with a built-in vent and drain group, as well as SET-K connection valves.

**OPT +GP 3D** - a manifold with a built-in vent and drain group, as well as connected mixing pump group with a three-way thermostatic valve.

The drain and vent group should be taken as additional outlet.

Code	Type	Brass manifold (Max. number of circuits)				InoxFlow manifold (Max. number of circuits)					
		STD	KPL	+GP H	KPL +GP H	STD	KPL	OPT	+GP H	KPL +GP 3D	OPT +GP 3D
1446180000	SWN-OP 580	10	6	2	5	9	5	7	-	4	4
1446180001	SWN-OP 780	12	10	6	9	13	9	11	5	8	8
1446180002	SWN-OP 930	12	12	9	12	13	12	12	8	11	11

 coil  bar  pipes in tube  bag  carton box  pallet **N** new  available soon

\* custom-made - lead time max 4 weeks | \*\* availability as agreed | \*\*\* while stock lasts



## Recess mounted cabinet SWP-OP

**GROUP: D**

Size (H×W×D) [mm]	*	Code			UM
750-850×580×110-160		<b>1446117003</b>	1	20	pc.
750-850×780×110-160		<b>1446117004</b>	1	17	pc.
750-850×930×110-160		<b>1446117005</b>	1	14	pc.

**Note:**

In the "Size" field, there is given:

- the external dimension of the cabinet body (the minimum dimension of the mounting cavity).

**STD** - a manifold without additional fixtures, with 1" stop end on one side.

**KPL** - a manifold with SET-K connection valves and a tee with an air vent and a drain valve in a beam.

**+GP H** - a manifold with an integrated set-point mixing unit.

**KPL +GP 3D** - a manifold with a vent and drain valve in a beam, as well as connected mixing pump group with a three-way thermostatic valve.

**OPT** - a manifold with a built-in vent and drain group, as well as SET-K connection valves.

**OPT +GP 3D** - a manifold with a built-in vent and drain group, as well as connected mixing pump group with a three-way thermostatic valve.

The drain and vent group should be taken as additional outlet.

Code	Type	Brass manifold (Max. number of circuits)				InoxFlow manifold (Max. number of circuits)					
		STD	KPL	+GP H	KPL +GP H	STD	KPL	OPT	+GP H	KPL +GP 3D	OPT +GP 3D
1446117003	SWP-OP 580	10	6	2	5	9	5	7	-	4	4
1446117004	SWP-OP 780	12	10	6	9	13	9	11	5	8	8
1446117005	SWP-OP 930	12	12	9	12	13	12	12	8	11	11

 coil 
  bar 
  pipes in tube 
  bag 
  carton box 
  pallet 
  new 
  available soon

\* custom-made - lead time max 4 weeks | \*\* availability as agreed | \*\*\* while stock lasts

## Basic+ - automation components

### Temperature sensor Basic+ with concealed setting (heating)

GROUP: A

Voltage	*	Code		UM
230 V		1802265131	1	pc.
24 V		1802265132	1	pc.

**Note:**  
The temperature sensor requires a 3-wire installation.



### Analogue thermostat Basic+ (heating)

GROUP: A

Voltage	*	Code		UM
230 V		1802265024	1	pc.
24 V		1802265025	1	pc.

**Note:**  
The thermostat works with servomotors of the following codes: 1802003004 and 1802003006 through the terminal blocks with the following codes: 1802212013, 1802212014, 1802212015, 1802212016. Required at least 3-wire installation.



### Analogue thermostat Basic+ (heating/cooling)

GROUP: A

Voltage	*	Code		UM
230 V		1802265032	1	pc.
24 V		1802265033	1	pc.

**Note:**  
The thermostat works with servomotors of the following codes: 1802003004 and 1802003006 through the terminal blocks with the following codes: 1802212013, 1802212014, 1802212015, 1802212016. Required at least 3-wire (heating) or 4-wire (cooling) installation.



### Thermostat Basic+ with LCD Standard (heating)

GROUP: A

Voltage	*	Code		UM
230 V		1802265020	1	pc.
24 V		1802265021	1	pc.

**Note:**  
The thermostat works with servomotors of the following codes: 1802003004 and 1802003006 through the terminal blocks with the following codes: 1802212013, 1802212014, 1802212015, 1802212016. Required at least 3-wire installation.



### Thermostat Basic+ with LCD Control (heating/cooling)

GROUP: A

Voltage	*	Code		UM
230 V		1802012004	1	pc.
24 V		1802012005	1	pc.

**Note:**  
The thermostat works with servomotors of the following codes: 1802003004 and 1802003006 through the terminal blocks with the following codes: 1802212013, 1802212014, 1802212015, 1802212016. Required at least 3-wire (heating) or 4-wire (cooling) installation.



 coil  bar  pipes in tube  bag  carton box  pallet **N** new  available soon

\* custom-made - lead time max 4 weeks | \*\* availability as agreed | \*\*\* while stock lasts



### Sensor for thermostat LCD Control Basic+ with cable

GROUP: A

	*	Code		UM
		1802012006	1	pc.



### Bimetallic room thermostat

GROUP: A

Voltage	*	Code		UM
230 V		1802265022	1	25 pc.
230 V / 24 V		1802265023	1	25 pc.

**Note:**

The thermostat works with servomotors of the following codes: 1802003004 and 1802003006 through the terminal blocks with the following codes: 1802212015, 1802212016, 1802212013 and 1802212014.

Thermostat 1802265022 - 3-wire.  
Thermostat 1802265023 - 2-wire.



### Weekly programmable room thermostat

GROUP: A

	*	Code		UM
	***	1802265128	1	5 pc.

**Note:**

The controller has battery power supply. Required at least 2-wire installation.



### Week controller with floor temperature sensor

GROUP: A

	*	Code		UM
		1802265038	1	20 pc.

**Note:**

Flush installation. Required at least 3-wire installation.



### Floor sensor for weekly thermostat.

GROUP: A

	*	Code		UM
		1802012002	1	pc.



### Terminal block Basic+ (heating/cooling) - 6 zones

GROUP: A

Voltage	*	Code		UM
230 V		1802212015	1	pc.
24 V		1802212016	1	pc.

coil bar pipes in tube bag carton box pallet **N** new available soon

\* custom-made - lead time max 4 weeks | \*\* availability as agreed | \*\*\* while stock lasts

### Terminal block Basic+ (heating/cooling) - 10 zones

GROUP: A

Voltage	*	Code		UM
230 V		1802212013	1	pc.
24 V		1802212014	1	pc.



### Power adapter for Basic+ terminal block

GROUP: A

Voltage	*	Code		UM
230 V / 24 V		1802265040	1	pc.



### Servomotor 230 V

GROUP: A

Version	*	Code		UM
NC		1802003004	1	pc.
NO	*	1802003003	1	pc.

**Note:**  
 No adapter included.  
 NC (normally closed) - de-energised closed  
 NO (normally open) - de-energised open



### Servomotor 230 V with M30×1.5 adapter

GROUP: A

N

Version	*	Code		UM
NC		1802212036	1	pc.

**Note:**  
 The servomotor has M30×1.5 adapter.  
 NC (normally closed) - de-energised closed



### Servomotor 24 V

GROUP: A

Version	*	Code		UM
NC		1802003006	1	pc.
NO	*	1802003005	1	pc.

**Note:**  
 No adapter included.  
 NC (normally closed) - de-energised closed  
 NO (normally open) - de-energised open



 coil  bar  pipes in tube  bag  carton box  pallet **N** new  available soon

\* custom-made - lead time max 4 weeks | \*\* availability as agreed | \*\*\* while stock lasts



### Servomotor 24 V with M30×1.5 adapter

GROUP: A

Version	*	Code		UM
N NC		1327098159	1	pc.

**Note:**  
The servomotor has M30×1.5 adapter.  
NC (normally closed) - de-energised closed



### Servomotor adapter

GROUP: A

Version	*	Code			UM
M30×1,5		1802003001	20	300	pc.

**Note:**  
M30×1.5 adapter can be used on servomotor valves in InoxFlow manifolds and thermostatic valves in pump groups 1346103000.  
The adapter works with SMART servomotors of the following codes: 1802003004, 1802003003, 1802003006, 1802003005.



## Smart - automation components

### Thermostat Smart with LCD, without floor temperature sensor **GROUP: A**

Version	*	Code		UM
2 x LR03/AAA		1802265019	1	pc.

**Note:** thermostat cannot operate with floor temperature sensor.



### Thermostat Smart with LCD, with floor temperature sensor **GROUP: A**

Version	*	Code		UM
2 x LR03/AAA		1802265039	1	pc.



### Terminal block Smart 230 V with LAN **GROUP: A**

Version	*	Code		UM
4/6		1802265008	1	pc.
8/12		1802265009	1	pc.
12/18		1802265007	1	pc.

**Note:**

4/6 - up to 4 thermostats and 6 servomotors  
 8/12 - up to 8 thermostats and 12 servomotors  
 12/18 - up to 12 thermostats and 18 servomotors



### Terminal block Smart 24 V with LAN and transformer **GROUP: A**

Version	*	Code		UM
4/6	***	1802265011	1	pc.
8/12	***	1802265012	1	pc.
12/18	***	1802265010	1	pc.

**Note:**

4/6 - up to 4 thermostats and 6 servomotors  
 8/12 - up to 8 thermostats and 12 servomotors  
 12/18 - up to 12 thermostats and 18 servomotors





### Servomotor 230 V

GROUP: A

Version	*	Code		UM
NC		1802003004	1	pc.
NO	*	1802003003	1	pc.

**Note:**  
 No adapter included.  
 NC (normally closed) - de-energised closed  
 NO (normally open) - de-energised open



### Servomotor 230 V with M30×1,5 adapter

GROUP: A

Version	*	Code		UM
<b>N</b> NC		1802212036	1	pc.

**Note:**  
 The servomotor has M30×1.5 adapter.  
 NC (normally closed) - de-energised closed



### Servomotor 24 V

GROUP: A

Version	*	Code		UM
NC		1802003006	1	pc.
NO	*	1802003005	1	pc.

**Note:**  
 No adapter included.  
 NC (normally closed) - de-energised closed  
 NO (normally open) - de-energised open



### Servomotor 24 V with M30×1,5 adapter

GROUP: A

Version	*	Code		UM
<b>N</b> NC		1327098159	1	pc.

**Note:**  
 The servomotor has M30×1.5 adapter.  
 NC (normally closed) - de-energised closed



### Servomotor adapter

GROUP: A

Version	*	Code			UM
M30×1,5		1802003001	20	300	pc.

**Note:**  
 M30×1.5 adapter can be used on servomotor valves in InoxFlow manifolds and thermostatic valves in pump groups 1346103000.  
 The adapter works with SMART servomotors of the following codes: 1802003004, 1802003003, 1802003006, 1802003005.

## External antenna Smart

GROUP: A

*	Code		UM
	1802010000	1	pc.

**Note:**

5 m connection cable is included.



## Signal repeater Smart

GROUP: A

*	Code		UM
	1802010002	1	pc.

**Note:**

Includes 230 V power supply.



 coil  bar  pipes in tube  bag  carton box  pallet **N** new  available soon

\* custom-made - lead time max 4 weeks | \*\* availability as agreed | \*\*\* while stock lasts

## Controllers, additional accessories and tools



### Smart servomotor adapter

GROUP: A

Version	*	Code			UM
M28×1,5		1802003002	20	160	pc.

**Note:**

Adapter M28×1.5 is used for valves installed in brass manifolds series 71A, 73A, 77E, 75A, 77A and 77E of KAN-therm system with servomotors on the upper beam. The adapter works with SMART servomotors of the following codes: 1802003004, 1802003003, 1802003006, 1802003005.



### Servomotor adapter

GROUP: A

Version	*	Code			UM
M30×1,5		1802003001	20	300	pc.

**Note:**

M30×1.5 adapter can be used on servomotor valves in InoxFlow manifolds and thermostatic valves in pump groups 1346103000. The adapter works with SMART servomotors of the following codes: 1802003004, 1802003003, 1802003006, 1802003005.



### Underfloor heating unit with valve, thermostatic head and air vent

GROUP: A

	*	Code		UM
	***	1802183000	1	pc.

**Note:**

The set is equipped with its manual air vent. The thermostatic head measures the air temperature in the room.



### Return temperature limiter and room controller Premium RTL Kombi UP DUO

GROUP: A

	*	Code		UM
<b>N</b>		1802265130	1	pc.



### Icing controller

GROUP: A

	*	Code		UM
	*	1802047003	1	pc.

**Note:**

The controller requires a snow and ice sensor, as well as a temperature and humidity sensor.

coil bar pipes in tube bag carton box pallet **N** new available soon

\* custom-made - lead time max 4 weeks | \*\* availability as agreed | \*\*\* while stock lasts

### Snow and ice sensor with 15 m wire

GROUP: A

	*	Code		UM
	*	1802047000	1	pc.

**Note:**

The snow and ice sensor works with icing controller for heating open areas, code 1802047003.



### Temperature and humidity sensor

GROUP: A

	*	Code		UM
	*	1802047001	1	pc.

**Note:**

The temperature and humidity sensor works with icing controller for heating open areas, code 1802047003.



### Tacker tool for clips

GROUP: K

	*	Code		UM
	*	1950267002	1	pc.

**Note:**

Tacker work with tape clips in short U42 (42 mm) and long U55 (55 mm) versions.



### Plastic Tacker tool for clips

GROUP: K

	*	Code		UM
	*	1950254001	1	pc.

**Note:**

Tacker work with tape clips in short U42 (42 mm) and long U55 (55 mm) versions.



### Adhesive tape hand feeder

GROUP: A

	*	Code		UM
	*	1800183009	1	pc.





### Pipe uncoiler

GROUP: K

	*	Code		UM
		1928270001	1	pc.



### Pipes guide arm for uncoiler

GROUP: K

	*	Code		UM
		1928270000	1	pc.



### TBS electric cutter

GROUP: K

	*	Code		UM
		1950267005	1	pc.

**Note:**  
TBS cutter with a tip is used to cut grooves for Ø16 pipes in complementary TBS boards.



### TBS cutter tip

GROUP: K

	*	Code		UM
		1950267000	1	pc.



### Combination wrench for G<sup>3/4</sup>" eurocone adapters

GROUP: K

Size [mm]	*	Code		UM
30	*	1938267035	1	15 pc.

**Note:**  
The wrench is intended for assembling G<sup>3/4</sup>" Eurocone adapters.



### Pipe cutter for PB

GROUP: K

Size [mm]	*	Code		UM
8x1		1950060000	1	pc.



### Pipe cutter

GROUP: K

Size [mm]	*	Code		UM
12-32		1938267050	1	25 pc.

coil bar pipes in tube bag carton box pallet **N** new available soon

\* custom-made - lead time max 4 weeks | \*\* availability as agreed | \*\*\* while stock lasts

## Pipe cutter blade

GROUP: K

Size [mm]	*	Code		UM
12-32	*	1938267055	1	pc.



## Pipe cutter for PERTAL pipes

GROUP: K

Range [mm]	*	Code		UM
14-32		1936267054	1	pc.



## Pipe cutter blade for PERTAL pipe

GROUP: K

Range [mm]	*	Code		UM
14-32		1936267059	1	pc.



## Calibrator for PERTAL pipes

GROUP: K

Size [mm]	*	Code		UM
14	*	1936267022	1	pc.
16		1936267026	1	pc.
20		1936267028	1	pc.
25 / 26		1936267030	1	pc.



## Universal calibrator for PERTAL pipes

GROUP: K

Size [mm]	*	Code		UM
16 / 20 / 25 / 26		1936267044	1	pc.



## Internal spring for pipes bending

GROUP: K


Size [mm]	*	Code			UM
16		1936267075	1	10	pc.
20		1936267077	1	10	pc.
25-26		1936267071	1	10	pc.

**Note:**  
The internal spring works with PERTAL pipes.



## External spring for pipes bending

GROUP: K

Size [mm]	*	Code			UM
16		1936267081	1	60	pc.
20		1936267086	1	40	pc.
25-26		1936267088	1	25	pc.

**Note:**  
The external spring works with PERTAL<sup>2</sup> and PERTAL pipes.



 coil  bar  pipes in tube  bag  carton box  pallet **N** new **i** available soon

\* custom-made - lead time max 4 weeks | \*\* availability as agreed | \*\*\* while stock lasts







Install your **future**

## THE PRODUCTS WITH THE LABEL KAN-therm ARE DISTRIBUTED TO 68 COUNTRIES IN THE WORLD.

The distribution network covers Europe, a large part  
of Asia and also reaches Africa and America.



---

[www.kan-therm.com](http://www.kan-therm.com)

# KAN-therm MULTISYSTEM

Complete multipurpose installation system consisting of state-of-the-art, mutually complementary technical solutions for pipe water distribution installations, heating and cooling installations, as well as technological installations.

ultra**LINE**

ultra**PRESS**

**PP Green**

**Steel**

**Inox**

**Groove**

**Copper, Copper Gas**

**Sprinkler**

**Surface heating and cooling,  
automation**

**Football  
Stadium installations**

**Cabinets  
and manifolds**

